

INDUKTIVNOSTI

Ind

SERIJA MCC
SERIJA SW45
SERIJA SW 68
SERIJA CW 8A
PROMENLJIVE INDUKTIVNOSTI
PRIGUŠNICE ZA RADIO SMETNJE
PRIGUŠNICE ZA STRUJNU KOMPENZACIJU
MEMORIJSKE PRIGUŠNICE
UNIVERZALNE PRIGUŠNICE
STRUJNI PRETVARAČI
SMD INDUKTIVNOSTI

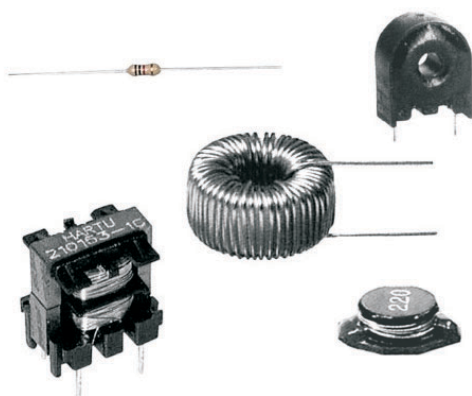

SERIJA MCC INDMCC

Tehnički podaci:

Tolerancija induktivnosti: ±10%

Napon izolacije: 250 V ms

Temperaturni opseg: -20°C - +100°C



Tip	Cena	L(μH)	I(mA)	R(Ω)	Q	f(MHz)	Dim.	
0,10	μH	0,90	0,10	1100	0,11	35	25,2	B
0,15	μH	0,90	0,15	1500	0,10	45	25,2	A
0,18	μH	0,90	0,18	1000	0,14	35	25,2	B
0,22	μH	0,90	0,22	990	0,16	35	25,2	B
0,33	μH	0,90	0,33	850	0,12	45	25,2	A
0,39	μH	0,90	0,39	790	0,22	35	25,2	B
0,47	μH	0,90	0,47	750	0,25	35	25,2	B
0,56	μH	0,90	0,56	700	0,28	35	25,2	B
0,68	μH	0,90	0,68	530	0,48	35	25,2	B
0,82	μH	0,90	0,82	500	0,55	35	25,2	B
1,0	μH	0,30	1,0	700	0,18	40	25,2	B
1,2	μH	0,90	1,2	630	0,25	40	7,96	B
1,5	μH	0,30	1,5	570	0,30	30	7,96	B
1,8	μH	0,90	1,8	540	0,30	40	7,96	B
2,2	μH	0,30	2,2	630	0,25	40	7,96	B
2,7	μH	0,90	2,7	480	0,40	40	7,96	B
3,3	μH	0,30	3,3	575	0,30	40	7,96	B
3,9	μH	0,90	3,9	400	0,55	40	7,96	B
4,7	μH	0,30	4,7	530	0,35	40	7,96	B
5,6	μH	0,90	5,6	500	0,40	40	7,96	B
6,8	μH	0,30	6,8	470	0,45	40	7,96	B
8,2	μH	0,90	8,2	240	1,6	50	7,96	B
10	μH	0,30	10	370	0,72	40	7,96	B
12	μH	0,90	12	190	2,4	50	2,52	B
15	μH	0,30	15	335	0,88	40	2,52	B
18	μH	0,90	18	580	0,67	60	2,52	B
22	μH	0,30	22	285	1,2	40	2,52	B
27	μH	0,90	27	160	3,6	60	2,52	B
33	μH	0,30	33	255	1,5	40	2,52	B
39	μH	0,90	39	470	1,02	50	2,52	B
47	μH	0,30	47	205	2,3	50	2,52	B
56	μH	0,90	56	195	2,6	60	2,52	B
68	μH	0,30	68	185	2,9	50	2,52	B
82	μH	0,90	82	175	3,2	55	2,52	B
100	μH	0,30	100	165	4,4	50	0,796	B
120	μH	0,90	120	160	3,8	60	0,796	B

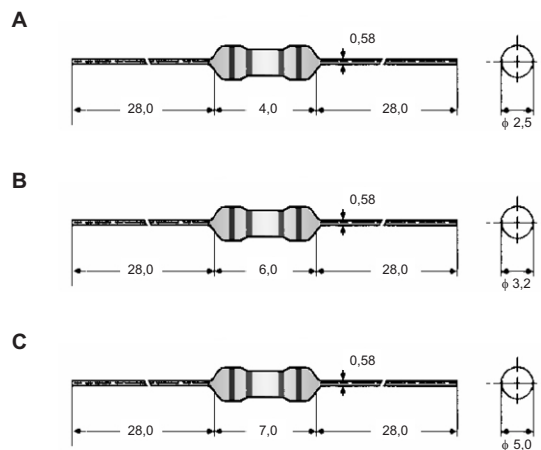

Tip	Cena	L(μH)	I(mA)	R(Ω)	Q	f(MHz)	Dim.	
150	μH	0,30	150	150	4,3	60	0,796	B
180	μH	0,90	180	135	5,3	60	0,796	B
220	μH	0,30	220	130	5,7	60	0,796	B
270	μH	0,90	270	115	7,8	60	0,796	B
330	μH	0,30	330	100	9,5	60	0,796	B
390	μH	0,90	390	180	7,0	70	0,796	B
470	μH	0,30	470	90	11,6	60	0,796	B
560	μH	0,90	560	160	8,8	60	0,796	B
680	μH	0,30	680	75	18	60	0,796	B
820	μH	0,90	820	140	12	50	0,796	B
1000	μH	0,30	1000	130	30	50	0,796	B
1500	μH	0,30	1500	100	23	50	0,252	B
1800	μH	0,90	1800	95	26	50	0,252	B
2200	μH	0,90	2200	80	34,7	40	0,252	B
2700	μH	0,90	2700	75	40	40	0,252	B
3300	μH	1,00	3300	62	59	40	0,252	B
4700	μH	1,00	4700	55	78	40	0,252	B
6800	μH	1,20	6800	35	85	30	0,252	B
10000	μH	1,50	10000	25	105	20	0,252	C

L = induktivnost, Q = faktor dobrote, I = nazivna struja max,
R = otpornost na jednosmernu struju max, f = rezonantna frekvencija

18000 Niš, Jovana Ristića 7, P.O.Box 135, Tel: 018/ 520-455, 522-814, 522-965, fax: 522-660
http://www.MGelectronic.co.yu e-mail: office@MGelectronic.co.yu

SERIJE SW I CW

SERIJA SW 45

Tehnički podaci:

Tolerancija induktivnosti: $\pm 10\%$

Napon izolacije: 250 V ms

Temperaturni opseg: $-20^{\circ}\text{C} - +85^{\circ}\text{C}$

Tip	Cena	L(μH)	I(mA)	R(Ω)
1,0 μH	0,40	1,0	1400	0,1
1,5 μH	0,40	1,5	1200	0,15
2,2 μH	0,40	2,2	1100	0,20
3,3 μH	0,40	3,3	1000	0,22
4,7 μH	0,40	4,7	800	0,26
6,8 μH	0,40	6,8	800	0,30
10 μH	0,40	10	700	0,46
15 μH	0,40	15	600	0,55
22 μH	0,40	22	500	0,72
33 μH	0,40	33	400	0,87
47 μH	0,40	47	400	1,0
68 μH	0,40	68	300	1,9
100 μH	0,40	100	200	3,0
150 μH	0,40	150	200	4,5
220 μH	0,40	220	200	5,8
330 μH	0,40	330	150	7,0
470 μH	0,40	470	120	8,0
680 μH	0,40	680	120	9,5
1000 μH	0,40	1000	100	17
1500 μH	0,40	1500	80	22
2200 μH	0,40	2200	60	26

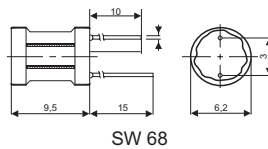
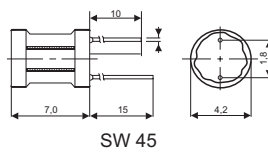

SERIJA SW 68

Tehnički podaci:

Tolerancija induktivnosti: $\pm 10\%$

Napon izolacije: 250 V ms

Temperaturni opseg: $-20^{\circ}\text{C} - +85^{\circ}\text{C}$

Tip	Cena	L(μH)	I(mA)	R(Ω)
10 μH	0,50	10	1300	0,09
15 μH	0,50	15	1050	0,11
22 μH	0,50	22	960	0,12
33 μH	0,50	33	800	0,19
47 μH	0,50	47	830	0,23
68 μH	0,50	68	750	0,37
100 μH	0,50	100	710	0,44
150 μH	0,50	150	600	0,73
220 μH	0,50	220	450	0,92
330 μH	0,50	330	400	0,15
470 μH	0,50	470	340	0,82
680 μH	0,50	680	250	3,25
1000 μH	0,50	1000	210	4,55
1500 μH	0,50	1500	180	7,54
2200 μH	0,50	2200	150	8,32
3300 μH	0,50	3300	130	10,92
4700 μH	0,50	4700	85	17,81
6800 μH	0,50	6800	65	27,3
10000 μH	0,50	10000	58	39
15000 μH	0,50	15000	53	65
22000 μH	0,50	22000	46	82
33000 μH	0,50	33000	38	135
47000 μH	0,50	47000	35	172

SERIJA CW8A

Tehnički podaci:

Tolerancija induktivnosti: $\pm 20\%$

Napon izolacije: 250 V ms

Temperaturni opseg: $-25^{\circ}\text{C} - +85^{\circ}\text{C}$

Tip	Cena	L(μH)	I(mA)	R(Ω)
1,0 μH	0,70	1,0	7200	0,012
4,7 μH	0,70	4,7	5100	0,0015
10 μH	0,70	10	3600	0,027
47 μH	0,70	47	1700	0,086
100 μH	0,70	100	1100	0,18
470 μH	0,70	470	560	0,71

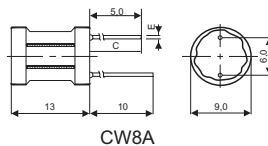

PROMENLJIVE INDUKTIVNOSTI

SERIJA BFCS

Tip	Cena	L(μA)	Oznaka	Opis
0,33 μH	1,00	0,33	8218 ± 3% min. Q 30/25 MHz	
0,47 μH	1,00	0,47	8219 ± 3% min. Q 30/25 MHz	
1,00 μH	1,00	1,0	8220 ± 3% min. Q 30/25 MHz	

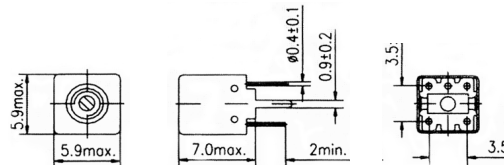

SERIJA KHS

Tip	Cena	L(μA)	Oznaka	Opis
0,10 μH	1,20	0,1	1241 ± 3% min. Q 30/25 MHz	
0,18 μH	1,20	0,18	1242 ± 3% min. Q 30/25 MHz	
0,33 μH	1,20	0,33	8222 ± 6% min. Q 55/25 MHz	
1,00 μH	1,20	1,0	2593 ± 6% min. Q 50/25 MHz	
2,70 μH	1,20	2,7	1243 ± 3% min. Q 35/25 MHz	
10 μH	1,20	10	1070 ± 6% min. Q 30/25 MHz	

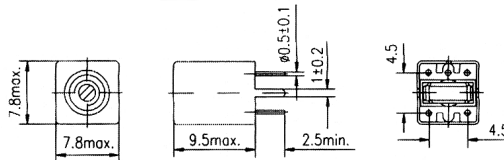

SERIJA OS45

Tip	Cena	L(μA)	Oznaka	Opis
150 μH	0,60	150	0846 ± 6% min. Q 65/1 MHz	
470 μH	0,60	470	1034 ± 6% min. Q 40/796 KHz	
1000 μH	0,60	1000	1033 ± 6% min. Q 60/796 KHz	

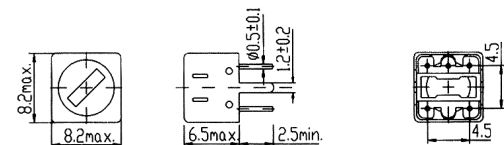

SERIJA FT39

Tip	Cena	Oznaka	Opis
1	0,50	845741	1 1/2 navoja
2	0,50	863019	2 1/2 navoja
3	0,50	863020	3 1/2 navoja

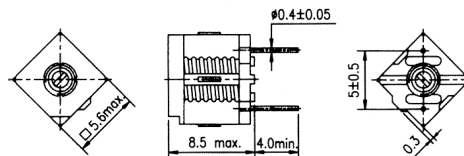

SERIJA EF 16 INDEF16

PRIGUŠNICE ZA OTKLANJANJE RADIO SMETNJI

- Efektno otklanjanje smetnji pomoću feritnog jezgra sa višim amplitudnim permebilitetom pri AC
- Minimalni gubici jezgra do 100 MHz
- Dobar učinak otklanjanja smetnji do 1 MHz
- Visoka mehanička stabilnost
- Malo rasipno polje

Tip	Cena	I _N (A)	L _o (mH)	L _N (mH)	R _{cu} (Ω)
250	4,00	3,60	0,05	0,039	0,053
251	4,00	2,20	0,20	0,140	0,150
253	4,00	1,25	0,74	0,520	0,450
254	4,00	0,80	1,50	1,050	0,920
255	4,00	1,00	1,00	0,70	0,75
256	4,00	0,75	1,80	1,260	1,250
257	4,00	0,62	3,00	2,100	1,900
258	4,00	0,44	5,60	3,920	3,800
259	4,00	0,38	8,00	5,600	4,900
260	4,00	0,33	10,00	7,00	6,50
262	4,00	0,22	24,00	16,800	15,500

I_N = nazivna struja, L_o = induktivnost praznog hoda
L_N = nazivna induktivnost, R_{cu} = otpornost na jednosmernu struju

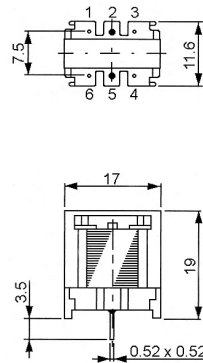
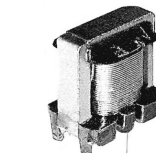

SERIJA EF 21 INDEF21

PRIGUŠNICE ZA STRUJNU KOMPENZACIJU

Tehnički podaci:

- Prenosni odnos: W1/W2 1:1
- Temperatura ambijenta: 40°C
- Nazivni napon: AC/DC 250 V
- Ispitni napon: namotaj-namotaj (50 Hz 2 sec.) 1500 V

Tip	Cena	L _o (mH)	I _N (A)	R _{cu} (Ω)
151	5,00	2 x 39	0,15	2 x 10,13
161	5,00	2 x 39	0,25	2 x 4,5

L_o = induktivnost praznog hoda +50% - 30% 100 μV
L_N = nazivna struja pri 40°C, R_{cu} = otpornost ±10% 20°C

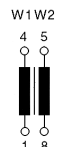
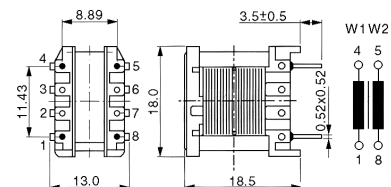
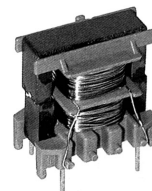
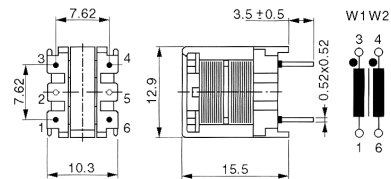
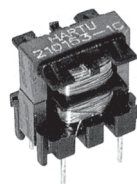

SERIJA SFT INDSFT

PRIGUŠNICE ZA OTKLANJANJE RADIO SMETNJI

- Otklanjanje smetnji u kolima sa tiristorima i trijacima
- Max. učestanost 10 MHz, faktor gubitka 14000

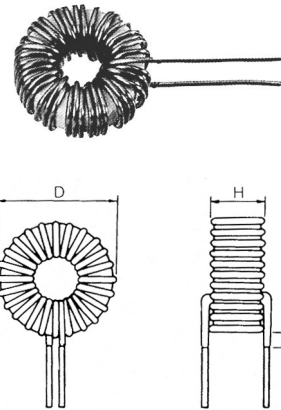

Tip	Cena	I_N (A)	L (μ H)	R_{DC} (mn)	Kern SF	Draht (ϕ mm)	Dimenzije (mm)		
							D	H	l
52501	3,00	2	20	42	T5	0,6	13	7,0	25
830S	3,00	2	26	55	T8s	0,6	17	9,5	30
850D	4,00	2	125	100	T8d	0,6	17	12,5	25
1030	3,50	3	40	40	T10	0,8	22	12,5	25
1230	7,00	5	35	30	T12	1,0	26	12,0	25
1240	5,00	5	64	40	T12	1,0	26	12,5	25

I_N = nazivna struja pri 100v AC, L = induktivnost min., R_{DC} = otpornost namotaja max.
D = prečnik, H = visina max., l = dužina izvoda

Tiristor

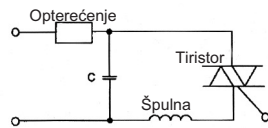

Prekidač

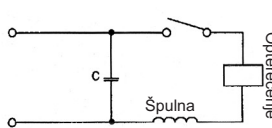

Poluprovodnik

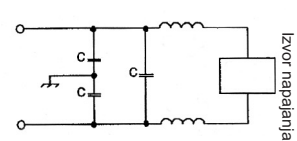

Smetnje

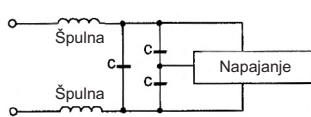

Eksterne smetnje

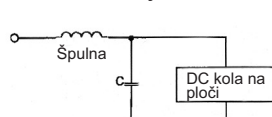

Pikovi

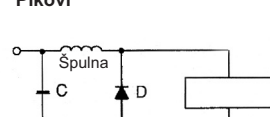

Korektno postavljena induktivnost

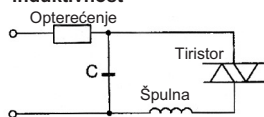

Korektno postavljen kondenzator

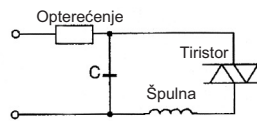

Loše postavljena induktivnost

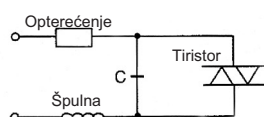

Loše postavljen kondenzator

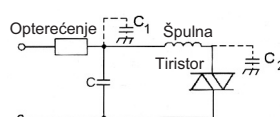

18000 Niš, Jovana Ristića 7, P.O.Box 135, Tel: 018/ 520-455, 522-814, 522-965, fax: 522-660
http://www.MGelectronic.co.yu e-mail: office@MGelectronic.co.yu

SERIJA HD INDHD

PRIGUŠNICE ZA OTKLANJANJE RADIO SMETNJI

- Otklanjanje smetnji u kolima sa tiristorima i trijacima
- Feritno jezgro, dvostruko izolovano
- Namotaji od lakirane bakarne žice

Tip	Cena	I _N (A)	aws (dB)	C (nF)	R _{CU} (mΩ)	P _{MN} (W)	L _O (mH)	L _{WS} (mH)	ΔT (k)	Dimenzije (mm)		
										Da	Di	H
12412	4,50	1,4	52	68	500	60	1,9	6,6	53	23,5	5	12
22260	4,50	1,8	54	68	450	60	2,5	8,3	50	36	13	11,5
22404	6,00	2,3	52	68	290	60	2,0	6,6	45	37	11	13
22278	8,00	2,3	53	68	350	60	2,7	7,4	53	39	15	11,5
32283	9,00	2,7	52	150	210	140	1,4	3,0	39	42	18	12
32284	5,50	2,7	54	150	240	60	1,5	3,7	37	37	12	11
32411	7,00	2,7	52	68	240	125	1,9	6,6	50	39	14	12
32300	9,00	4,0	54	150	150	150	1,5	3,7	57	40	14	17
32302	9,00	4,5	54	220	120	175	1,1	2,5	50	42	17	13
32011	12,00	4,5	53	220	120	75	1,0	2,3	52	42	16	13
32320	12,00	6,0	52	220	90	75	1,0	2,0	54	42	16	21
32321	15,00	6,0	54	220	90	150	1,1	2,5	58	42	16	21
32343	20,00	10	55	330	45	250	0,59	1,9	68	45	17	20

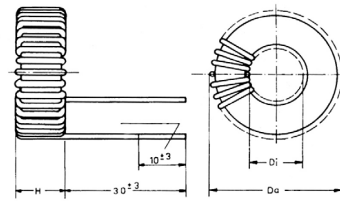

I_N = nazivna struja, aws = efektivno prigušenje, C = kondenzator, R_{CU} = unutrašnja otpornost, P_{MN} = minimalna snaga, L_O = nazivna induktivnost, L_{WS} = efektivna induktivnost, DT = zagrevanje pri 40°C temperature okoline, Da = spoljni prečnik, Di = unutrašnji prečnik, H = visina

SERIJA HSD INDHSD

MEMORIJSKE PRIGUŠNICE

Tip	Cena	I _N (A)	L _O (μH)	L _N (μH)	R _{CU} (mΩ)	Dimenzije (mm)		
						Da	Di	H
3606	5,00	1,0	220	180	145	23	4	10
3609	6,00	1,0	2280	1230	565	31	9	13
3622	5,00	2,5	185	100	57	26	5	11
3623	12,00	2,5	800	400	140	36	12	12
3633	13,00	5,0	800	330	80	40	14	17
3634	12,00	5,0	1400	520	105	43	16	20

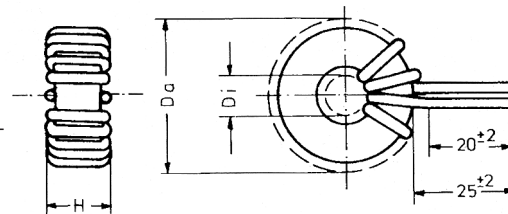
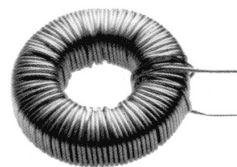

I_N = nazivna snaga, L_O = induktivnost praznog hoda, L_N = induktivnost pod opterećenjem, R_{CU} = sopstvena otpornost, Da = spoljni prečnik, Di = unutrašnji prečnik, H = visina

SERIJA RSD42 INDRSD

PRIGUŠNICE ZA STRUJNU KOMPENZACIJU

Tehnički podaci:

Nazivni napon: 250 V

Tolerancija induktivnosti: $\pm 30\%$

Gubitak induktivnosti: $< 10\%$ pri I_n

Ispitni napon: 1500 V 50 Hz 2 sec.

Zagrevanje namotaja: $< 55^\circ\text{C}$ pri I_n

Max. temperatura namotaja: 115°C

Tip	Cena	I_n (A)	Raster (mm)
H 1710	4,00	1,0	10
H 1720	4,00	2,0	10
H 1725	4,00	2,5	10
H 1730	4,00	3,0	10
H 2203	4,00	0,3	12,5
H 2205	4,00	0,5	12,5
H 2210	4,00	1,0	12,5
H 2220	4,00	2,0	12,5
H 2230	4,00	3,0	12,5
H 2710	4,50	1,0	15
H 2740	4,50	4,0	15
H 3220	5,00	2,0	20
H 3240	5,00	4,0	20
H 3260	5,00	6,0	20
H 4280	9,00	8,0	15
H 42100	9,00	10	15

I_n = nazivna struja po namotaju

Tip	Cena	I_n (A)	Raster (mm)
V 2010	4,00	1,0	15
V 2020	4,00	2,0	15
V 2025	4,00	2,5	15
V 2030	4,00	3,0	15
V 2503	4,00	0,3	10
V 2505	4,00	0,5	10
V 2510	4,00	1,0	10
V 2520	4,00	2,0	10
V 2530	4,00	3,0	10
V 3010	4,50	1,0	12,5
V 3020	4,50	2,0	12,5
V 3040	4,50	4,0	12,5
V 3205	5,00	0,5	12,5
V 3210	5,00	1,0	12,5
V 3215	5,00	1,5	12,5
V 3220	5,00	2,0	12,5
V 3240	5,00	4,0	12,5
V 3260	5,00	6,0	12,5

I_n = nazivna struja po namotaju

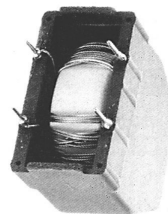
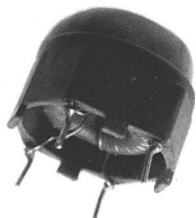

SERIJA RSD42 INDRSD

Horiz.	Vertik.	I_N (A)	L_o (mH)	R_N (mΩ)
1710	2010	1,0	6,8	400
1720	2020	2,0	3,9	80... 100
1725	2025	2,5	2,7	120... 160
1730	2030	3,0	1,0	50

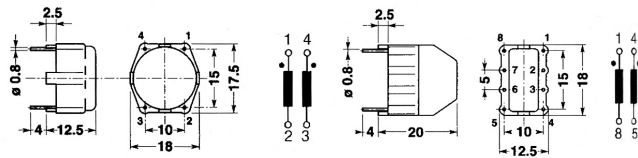

Horiz.	Vertik.	I_N (A)	L_o (mH)	R_N (mΩ)
2203	2503	0,3	47,0	1400
2205	2505	0,5	27,0	900
2210	2510	1,0	10,0	450
2220	2520	2,0	2,2	70
2230	2530	3,0	1,2	70

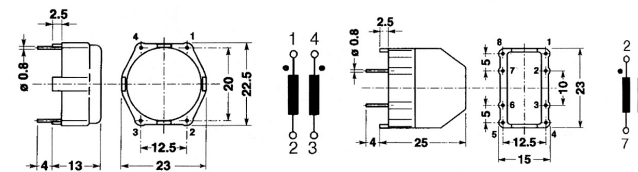

Horiz.	Vertik.	I_N (A)	L_o (mH)	R_N (mΩ)
2710	3010	1,0	27,0	600
-	3020	2,0	5,6	170
2740	3040	4,0	2,7	45

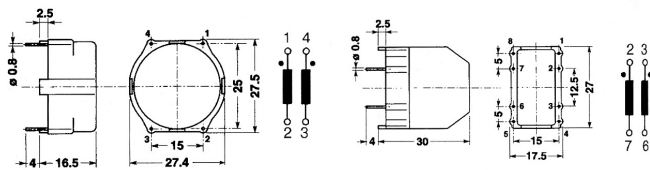

Horiz.	Vertik.	I_N (A)	L_o (mH)	R_N (mΩ)
-	3210	1,0	47,0	660
-	3215	1,5	22,0	250
3220	3220	2,0	6,8	120
3240	3240	4,0	3,3	54
3260	3260	6,0	1,8	25

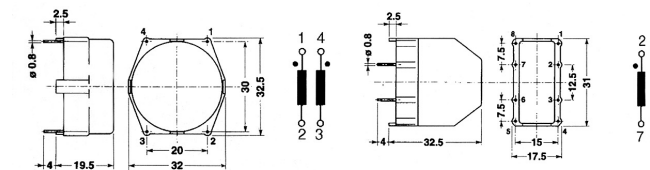

Horiz.	Vertik.	I_N (A)	L_o (mH)	R_N (mΩ)
4280	-	8,0	2,7	22
42100	-	10,0	1,8	14

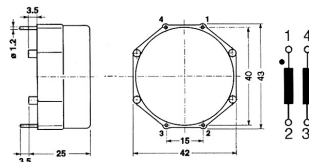

I_N = nazivna struja po namotaju, L_o = nazivna induktivnost po namotaju, R_N = nazivna otpornost po namotaju

SERIJA DPU INDDPU

UNIVERZALNE PRIGUŠNICE

0,5 A

Tip	Cena	I _N (A)	L _N (μH)	L _o (μH)	R _{cu} (Ω)	E	Dimenzije (mm)	
							a	b
047	2,00	0,50	47	50	0,095	5,9	14	8
100	2,00	0,50	100	109	0,140	12,5	14	8
150	2,00	0,50	150	167	0,173	18,8	15	8
220	2,20	0,50	220	258	0,215	27,5	15	9
330	2,50	0,50	330	393	0,265	41,3	15	9
470	3,00	0,50	470	557	0,322	58,8	20	9

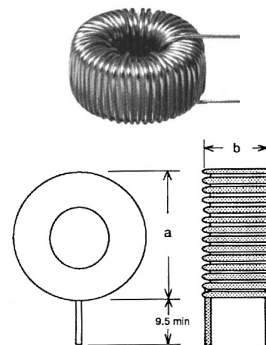

1 A

Tip	Cena	I _N (A)	L _N (μH)	L _o (μH)	R _{cu} (Ω)	E	Dimenzije (mm)	
							a	b
033	2,00	1,00	33	37	0,052	16,5	14	8
047	2,00	1,00	47	53	0,063	23,5	14	8
068	2,20	1,00	68	80	0,077	34	14	8
100	2,20	1,00	100	127	0,097	50	15	8
150	2,50	1,00	150	207	0,123	75	15	9
220	2,50	1,00	220	345	0,196	110	15	9
330	3,00	1,00	330	491	0,193	165	20	9
470	4,00	1,00	470	601	0,180	235	27	12
680	4,50	1,00	680	891	0,220	340	27	13
1000	5,00	1,00	1000	1619	0,426	500	28	13

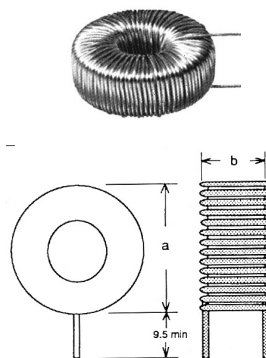

2 A

Tip	Cena	I _N (A)	L _N (μH)	L _o (μH)	R _{cu} (Ω)	E	Dimenzije (mm)	
							a	b
022	2,00	2,0	22	27	0,070	4	14	8
047	2,00	2,0	47	73	0,090	94	15	8
068	2,00	2,0	68	109	0,089	136	15	8
100	2,50	2,0	100	157	0,109	200	15	9
150	3,00	2,0	150	207	0,106	300	25	12
220	3,50	2,0	220	328	0,153	440	25	11
330	4,00	2,0	330	575	0,202	660	26	12

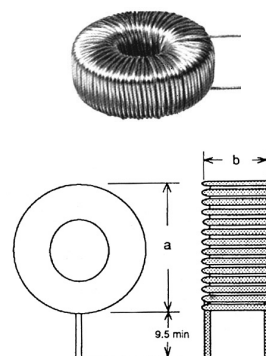

I_N = nazivna struja, L_N = nazivno opterećenje min.,
L_N = induktivnost praznog hoda (0,1V AC a 10KHz ±15%)
R_N = unutrašnja otpornost, E = memorijska energija min.

SERIJA DPU INDDPU

UNIVERZALNE PRIGUŠNICE

3 A

Tip	Cena	I _N (A)	L _N (μH)	L _o (μH)	R _{cu} (Ω)	E	Dimenzije (mm)	
							a	b
022	2,00	3,00	22	34	0,050	99	14	8
033	2,50	3,00	33	49	0,038	149	19	8
047	2,50	3,00	47	75	0,048	212	20	8
068	3,00	3,00	68	92	0,060	306	25	12
100	3,20	3,00	100	157	0,080	458	25	12
150	3,60	3,00	150	256	0,107	675	25	12
220	5,00	3,00	220	346	0,134	990	29	13
330	6,00	3,00	330	625	0,142	1485	30	14
470	10,00	3,00	470	727	0,187	2115	42	14

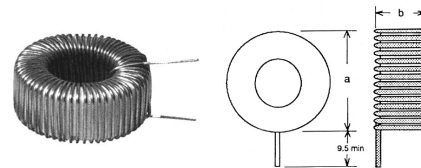

5 A

Tip	Cena	I _N (A)	L _N (μH)	L _o (μH)	R _{cu} (Ω)	E	Dimenzije (mm)	
							a	b
033	3,00	5,00	33	48	0,036	413	25	12
047	3,20	5,00	47	82	0,043	588	25	12
068	3,50	5,00	68	137	0,055	850	26	12
100	5,00	5,00	100	172	0,059	1250	30	13
150	8,50	5,00	150	221	0,094	1875	41	13
220	9,50	5,00	220	381	0,097	2750	41	13

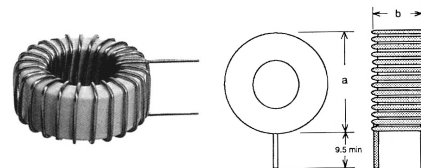

7,5 A

Tip	Cena	I _N (A)	L _N (μH)	L _o (μH)	R _{cu} (Ω)	E	Dimenzije (mm)	
							a	b
022	4,50	7,5	22	30	0,025	619	30	14
033	5,00	7,5	33	49	0,025	928	30	14
047	5,50	7,5	47	84	0,026	1322	31	14
068	9,00	7,5	68	105	0,040	1913	42	14

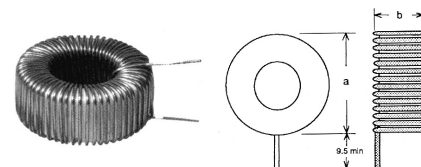

10 A

Tip	Cena	I _N (A)	L _N (μH)	L _o (μH)	R _{cu} (Ω)	E	Dimenzije (mm)	
							a	b
068	14,00	10	68	89	0,042	3400	50	21
100	15,00	10	100	152	0,044	5000	50	21

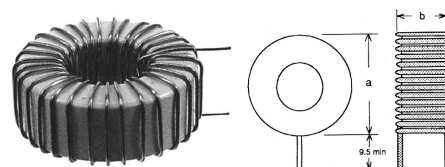

I_N = nazivna struja, L_N = nazivno opterećenje min.,
 L_N = induktivnost praznog hoda (0,1V AC a 10KHz ±15%)
 R_N = unutrašnja otpornost, E = memorijska energija min.

SERIJA DPVG INDDPVG

PRIGUŠNICE ZA OTKLANJANJE SMETNJI

1 A

Tip	Cena	I _N (A)	L _N (μH)	L _o (μH)	R _{cu} (Ω)	E
100	3,50	1,00	100	127	0,097	50
150	4,00	1,00	150	207	0,123	75
220	4,00	1,00	220	345	0,196	110
330	4,50	1,00	330	491	0,193	165

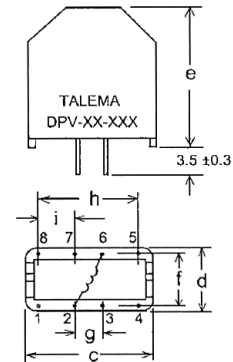
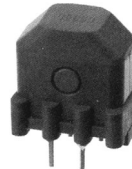

Dimenzije (mm)

Tip	c	d	e	f	g	h	i	PIN Ø
100	17,8	12,8	20	10,0	5,0	15	5	0,6x0,88
150	23,0	15,5	25	12,5	10,0	20	5	0,6x0,88
220	23,0	15,5	25	12,5	10,0	20	5	0,6x0,88
330	23,0	15,5	25	12,5	10,0	20	5	0,6x0,88

3 A

Tip	Cena	I _N (A)	L _N (μH)	L _o (μH)	R _{cu} (Ω)	E
033	4,00	3,00	33	49	0,038	149
047	4,50	3,00	47	75	0,048	212
100	5,50	3,00	100	157	0,080	458
220	7,50	3,00	220	346	0,314	990

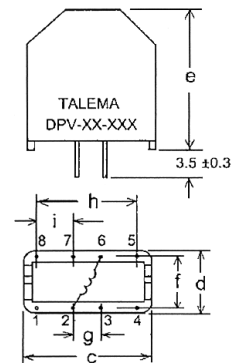

Dimenzije (mm)

Tip	c	d	e	f	g	h	i	PIN Ø
033	23,0	15,5	25	12,5	10,0	20,0	5	0,6x0,88
047	23,0	15,5	25	12,5	10,0	20,0	5	0,6x0,88
100	27,0	18,0	30	15,0	12,5	22,5	5	0,6x0,88
220	32,0	20,5	35	17,5	12,5	27,5	7,5	0,75x1,10

Temperatura ambijenta 25°C
 I_N = Nazivna struja
 L_N = Induktivno opterećenje min.
 L_o = Induktivnost praznog hoda (0,1V AC pri 10kHz ±15%)
 R_{cu} = Sopstvena otpornost max.
 E =Memorijska energija min.

18000 Niš, Jovana Ristića 7, P.O.Box 135, Tel: 018/ 520-455, 522-814, 522-965, fax: 522-660
<http://www.MGelectronic.co.yu> e-mail: office@MGelectronic.co.yu

SERIJA ASM INDASM

STRUJNI PRETVARAČI

Tehnički podaci:

Izolacioni napon: primaran/sekundaran 2500 V AC

Merna učestanost: 50/60 Hz

Temperaturni opseg: -40°C + 120°C

Tip	Cena	Merni opseg (A)	Tolerancija (%)
10	5,00	1.....10	±10
50	14,00	5.....50	±10
100	14,00	5.....100	±10

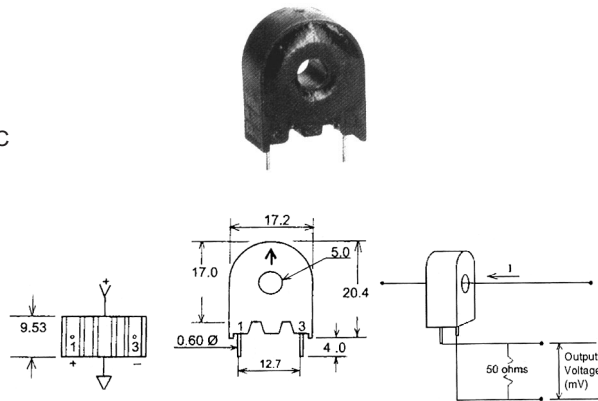

SERIJA AC INDAC

STRUJNI PRETVARAČI

Tehnički podaci:

Odnos namotaja: 1000:1

Otpornost opterećenja: 100Ω

Tip	Cena	I _p (A)	P _{RL100} (W)	U _{A100} (V/A)	U _{A500} (V/A)	U _{A2k} (V/A)	Dimenzije (mm)					
							L	D	H	W	C	D
1005	10,00	5	0,0025	0,10	0,46	1,43	23,8	9,5	23,8	11,2	15,24	7,62
1010	10,00	10	0,0100	0,10	0,45	1,10	23,8	9,5	23,8	11,2	15,24	7,62
1015	10,00	15	0,0230	0,10	0,45	0,90	23,8	9,5	23,8	11,2	15,24	7,62
1020	10,00	20	0,0400	0,10	0,43	0,76	23,8	9,5	23,8	11,2	15,24	7,62
1025	14,00	25	0,0630	0,10	0,47	1,06	30,2	11,4	30,2	14,30	20,32	10,16
1040	15,00	40	0,1600	0,10	0,46	0,67	34,9	14,6	34,9	14,30	25,40	10,16
1050	15,00	50	0,2500	0,10	0,43	0,76	34,9	14,6	34,9	14,30	25,40	10,16

I_p = Nazivna ulazna struja

P_{RL100} = Snaga otpornog opterećenja (100W)

U_{A100} = Izlazni napon prema ulaznoj struji pri 100Ω

U_{A500} = Izlazni napon prema ulaznoj struji pri 500Ω

U_{A2k} = Izlazni napon prema ulaznoj struji pri 2kΩ

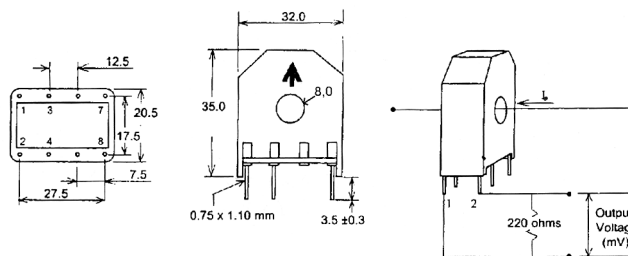

SERIJA 1210

Tip	Cena	L (μ H)	Q (MHz)	f _Q (MHz)	f (MHz)	R _{DU} (Ω)	I _N (mA)
N100	0,80	0,10	30	50,0	700	0,44	450
N047	0,80	0,47	30	25,2	220	0,50	450
U001	0,80	1,0	30	7,96	120	0,70	400
U004,7	0,80	4,7	30	7,96	50	1,5	224
U010	0,80	10	30	2,52	33	2,1	189
U047	1,00	47	30	2,52	14	9,0	91
U100	1,00	100	20	0,796	9	14,0	73

L = induktivnost, Q = faktor dobrote,
f_Q = ispitna učestanost u zavisnosti L i Q, f = rezonantna učestanost,
R_{DC} = otpornost na jednosmernu struju, I_N = nazivna max. struja

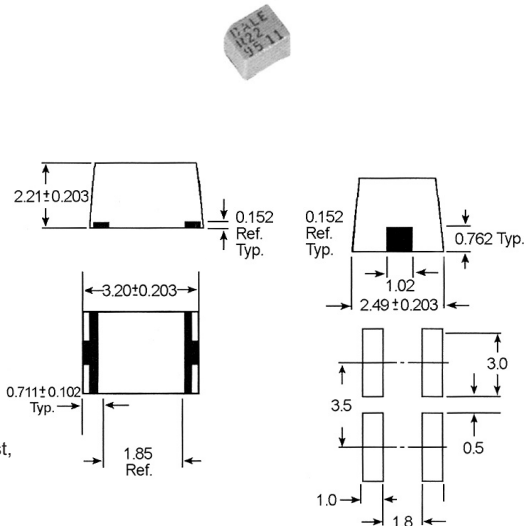

SERIJA 1812

Tip	Cena	L (μ H)	Q (MHz)	f _Q (MHz)	f (MHz)	R _{DU} (Ω)	I _N (mA)
N100	1,00	0,10	30	25,2	650	0,32	450
N470	1,00	0,47	30	25,2	190	0,80	355
U001	1,00	1,0	50	7,96	100	0,50	450
U004,7	1,00	4,7	50	7,96	35	1,00	315
U010	1,00	10	50	2,52	20	1,60	250
U047	1,00	47	50	2,52	10	5,00	140
U100	1,50	100	40	0,79	8,0	8,00	110
U470	1,80	470	40	0,79	3,0	26,0	62
M001	1,80	1000	30	0,25	2,5	40,0	30

L = induktivnost, Q = faktor dobrote,
f_Q = ispitna učestanost u zavisnosti L i Q, f = rezonantna učestanost,
R_{DC} = otpornost na jednosmernu struju, I_N = nazivna max. struja

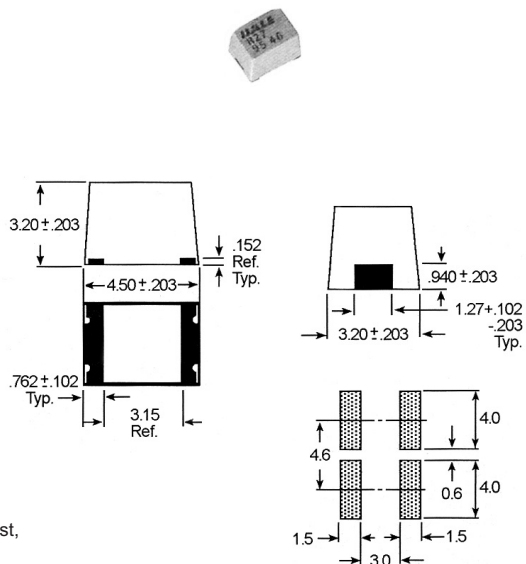

SMD INDUKTIVNOSTI INDSMD

**SERIJA LP
MINIJATURNE PRIGUŠNICE**

Tip	Cena	Paralel			Serijski			E
		I_N (mA)	f_o (MHz)	R_{DC} (Ω)	I_N (mA)	f_o (MHz)	R_{DC} (Ω)	
1U33	3,50	0,76	33	133	0,38	132	532	7,2
1U100	4,50	0,44	100	376	0,22	400	1504	7,2
2U47	3,50	1,08	47	139	0,54	188	556	21,2
2U220	5,00	0,44	220	784	0,22	880	3136	15,8
3U10	2,50	3,00	10	26	1,5	40	104	32,8
3U100	2,50	0,94	100	250	0,47	400	1000	32,2
4U150	3,20	0,88	150	307	0,44	600	1228	42,8
4U470	3,50	0,50	470	900	0,25	1880	3600	43,6
5U22	3,00	3,00	22	38	1,50	88	152	71,6
5U220	3,50	0,94	220	298	0,47	880	1192	71,5

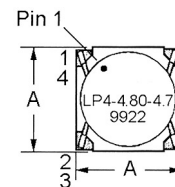

I_N = nazivna struja, L_o = induktivnost praznog hoda $\pm 15\%$,
 R_{DC} = otpornost na jednosmernu struju, E = memorijska energija

Tip	Dimenzije u (mm)					
	A	B	C	D	E	H
1U33	7,0	2,0	2,5	8,0	7,0	4,7
1U100	7,0	2,0	2,5	8,0	7,0	4,7
2U47	9,0	2,5	3,0	10,0	9,0	5,9
2U220	9,0	2,5	3,0	10,0	9,0	5,9
3U10	11,0	2,5	3,0	12,0	11,0	6,3
3U100	11,0	2,5	3,0	12,0	11,0	6,3
4U150	12,0	3,0	3,5	13,0	12,0	6,3
4U470	12,0	3,0	3,5	13,0	12,0	6,3
5U22	12,0	3,0	3,5	13,0	12,0	8,3
5U220	12,0	3,0	3,5	13,0	12,0	8,3

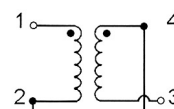
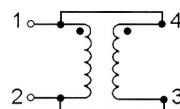
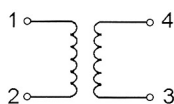
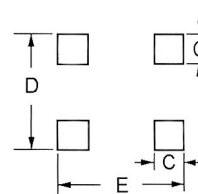
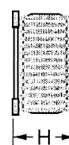
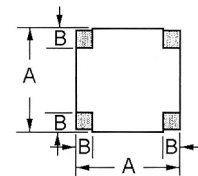

SMD INDUKTIVNOSTI

INDSMD

**SERIJA TSL
SNAŽNE INDUKTIVNOSTI**

Tip	Cena	L_N (μ H)	f_L (kHz)	D_{CR} (Ω)	I_N^1 (mA)	I_N^2 (mA)
1R0	4,00	1,0	100	0,009	9,0	6,8
2R2	4,00	2,2	100	0,012	7,0	6,1
4R7	4,00	4,7	100	0,018	5,4	4,8
100	4,00	10	100	0,038	3,8	3,9
150	4,00	15	100	0,049	3,0	3,1
220	4,00	22	100	0,085	2,6	2,7
330	4,00	33	100	0,100	2,0	2,1
470	4,00	47	100	0,140	1,6	1,8
560	4,00	56	100	0,162	1,5	1,7
680	4,00	68	100	0,200	1,4	1,5
101	4,00	100	100	0,280	1,2	1,3
221	4,00	220	100	0,610	0,8	0,8
471	4,00	470	100	1,270	0,5	0,5
102	4,00	1000	100	3,00	0,3	0,3

L_N = nazivna induktivnost, f_L = ispitna učestanost,
 D_{CR} = otpornost na jednosmernu struju,
 I_N^1 = struja max. pri smanjenju induktivnosti od 10%,
 I_N^2 = struja max. pri 30°C

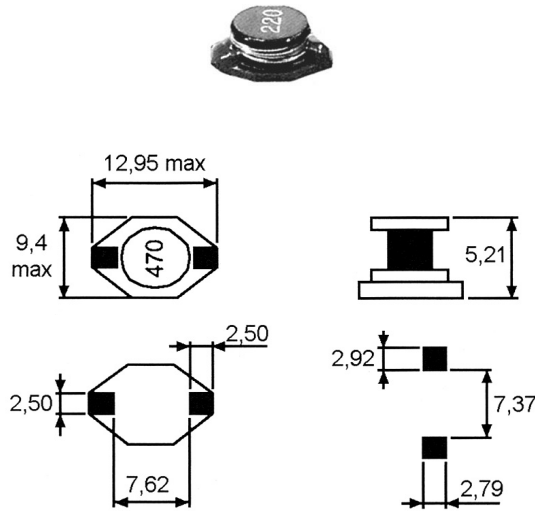

**SERIJA CMM
SIGNALNE PRIGUŠNICE**

Tip	Cena	L_N (μ H)	I_N (mA)	L_L (μ H)	R_{Cu} (m Ω)
2 - 470	4,00	2 x 47	500	0,20	130
2 - 101	4,00	2 x 100	500	0,25	260
2 - 102	4,00	2 x 1000	500	0,25	250
2 - 472	4,00	2 x 4700	200	0,50	840
4 - 470	4,50	4 x 47	500	0,25	180
4 - 101	4,50	4 x 100	500	0,30	330
4 - 102	4,50	4 x 1000	500	0,35	310
4 - 472	4,50	4 x 4700	200	0,70	860

L_N = nazivna induktivnost, I_N = nazivna struja,
 L_L = induktivnost, R_{Cu} = unutrašnja otpornost

