

WP1.2-6 6V 1.2Ah

Specifications

Nominal Voltage(V) **6V**

Nominal Capacity

20 hour rate	(0.06A to 5.25V)	1.2Ah
10 hour rate	(0.114A to 5.25V)	1.14Ah
5 hour rate	(0.204A to 5.1V)	1.02Ah
1 C	(1.2A to 4.8V)	0.68Ah
3 C	(3.6A to 4.8V)	0.48Ah

Weight **Approx. 310g(0.68Lbs.)**

Internal Resistance (at 1KHz) **Approx. 41 mΩ**

Maximum Discharge Current for

5 seconds: **18A**

Charging Methods at 25 (77)

Cycle use:

Charging Voltage **7.20 to 7.50V**

Coefficient -5.0mv/ /cell

Maximum Charging Current : **0.36A**

Standby use:

Float Charging Voltage **6.75 to 6.90V**

Coefficient -3.0mv/ /cell

Operating Temperature Range

Charge **-15 (5) to 40 (104)**

Discharge **-15 (5) to 50 (122)**

Storage **-15 (5) to 40 (104)**

Charge Retention (shelf life) at 20 (68)

1 month **92%**

3 month **90%**

6 month **80%**

Case Material

ABS

(Option: UL94 HB & UL94 V-0 flame retardant)

Terminal

F1 or F2 (Faston Tab 187 or 250)



Dimensions

mm(inch)

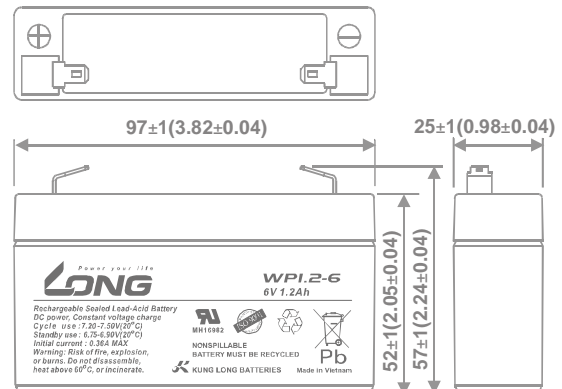
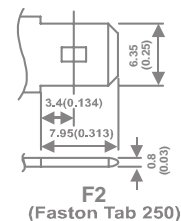
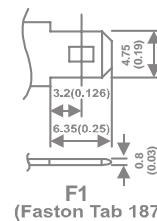

(V) Discharge Time VS. Discharge Current (25)

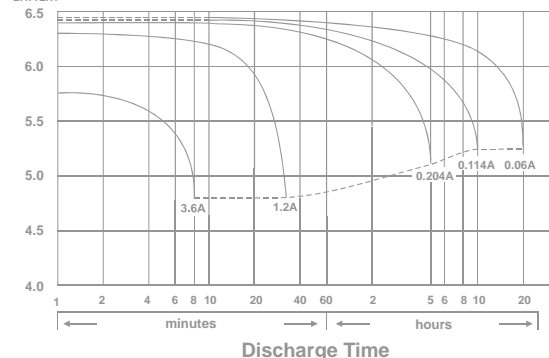

Effect of Temperature on Capacity 25 (77)

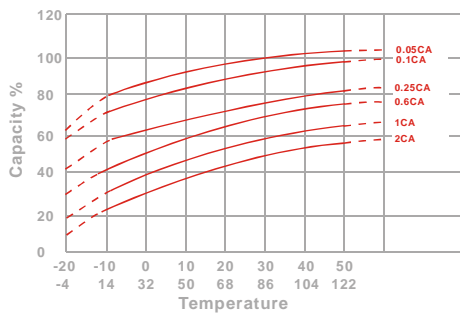

Capacity Retention Characteristic

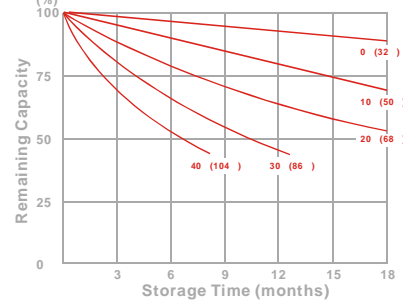

Trickle (or float) Service Life

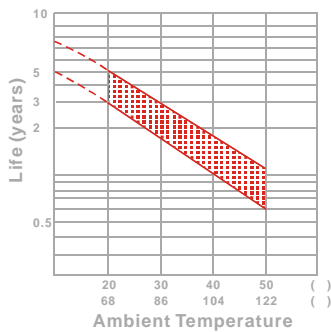

Cycle Service Life

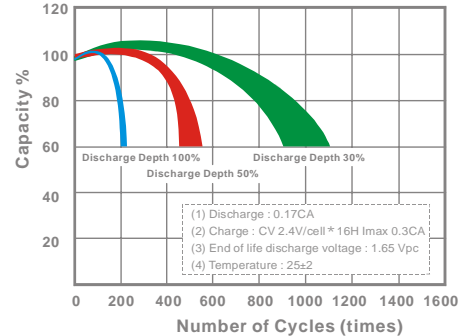

- PERFORMANCE DATA

Discharge Rates in Watts to Various End Voltages at 25 (77)

End Voltage		1.85V	1.80V	1.75V	1.70V	1.67V	1.65V	1.60V
Time								
5	min	21.6	23.5	24.8	26.0	26.4	27.0	27.9
10	min	13.9	15.0	15.9	16.6	16.8	17.0	17.3
15	min	11.0	11.6	12.2	12.6	12.8	13.0	13.2
30	min	6.45	6.75	6.95	7.10	7.15	7.25	7.35
60	min	3.96	4.18	4.30	4.40	4.44	4.49	4.55
120	min	2.24	2.43	2.54	2.63	2.66	2.70	2.75
180	min	1.60	1.72	1.81	1.87	1.90	1.94	1.97
240	min	1.31	1.41	1.49	1.54	1.56	1.59	1.61
300	min	1.26	1.33	1.37	1.41	1.42	1.43	1.45
600	min	0.660	0.700	0.730	0.750	0.755	0.765	0.775
1200	min	0.369	0.379	0.386	0.390	0.392	0.394	0.396

- Discharge Rates in Amperes to Various End Voltages at 25 (77)

End Voltage		1.85V	1.80V	1.75V	1.70V	1.67V	1.65V	1.60V
Time								
5	min	3.49	4.11	4.57	4.94	5.09	5.26	5.51
10	min	2.12	2.43	2.63	2.81	2.88	2.96	3.11
15	min	1.71	1.95	2.09	2.20	2.24	2.29	2.35
30	min	0.931	1.06	1.17	1.24	1.26	1.29	1.32
60	min	0.680	0.716	0.735	0.759	0.765	0.772	0.779
120	min	0.392	0.415	0.429	0.440	0.444	0.449	0.456
180	min	0.272	0.291	0.302	0.311	0.314	0.318	0.324
240	min	0.223	0.238	0.247	0.254	0.257	0.260	0.264
300	min	0.207	0.219	0.226	0.231	0.233	0.236	0.238
600	min	0.112	0.117	0.121	0.124	0.125	0.126	0.127
1200	min	0.0615	0.0624	0.0631	0.0637	0.0639	0.0642	0.0646

All data on the spec. sheet is an average value:

The tolerance range : X<6min(+15%~-15%), 6min X<10min(+12%~-12%),10min X < 60min(+8%~-8%), X 60min(+5%~-5%)

180113-1D



Head Quarter Service - TEL: +886-49-2254-777 FAX: +886-49-2255-139 E-mail: sales@mail.klb.com.tw
 USA Customer Service - TEL: +1-949-328-7936 FAX: +1-949-266-9917 E-mail: sales@kunglong.com
 Vietnam Customer Service - TEL: +84-72-3779666 FAX: +84-72-3779476 E-mail: sales@mail.klb.com.tw