



Product information MAB 5100 S grau/grey

Industrial Connecting Solutions: Circular Connectors: Audio/Video Connectors: DIN EN 60 130-09 Connectors (MAS/MAK series): with locking screw: Panel-mounted sockets: MAB 5100 S grau/grey
<http://www.e-catalog.beldensolutions.com/link/57078-24228-256281-256282-24384-24391-24392-34648/en/conf/uistate>

Name	MAB 5100 S grau/grey
	
	panel-mounted socket with locking screw; solder joint; not shielded
Delivery informations	
Availability	available
Product description	
Type	MAB 5100 S grau/grey
Order No.	930 953-517
Type of contact	female
Colour	grey
Description	panel-mounted socket with locking screw; solder joint; not shielded
Number of contacts	5
Conductor size	$\leq 0.34 \text{ mm}^2$
Technical data	
LF output "Phone"	EN 60 130-09
Pole arrangement DIN	DIN 41 524
Rated current	4 A
Rated voltage	AC/DC 34 V
Type of termination	solder
Material	
Contact material (socket)	brass
Contact surface material	tin plated
Contact bearer material	PA 66/UL standard 94V-2
Housing material	PE
Environmental conditions	
Protection class (IEC 60529)	IP 30
Temperature range	-20 °C to +60 °C

Picture
Drawing

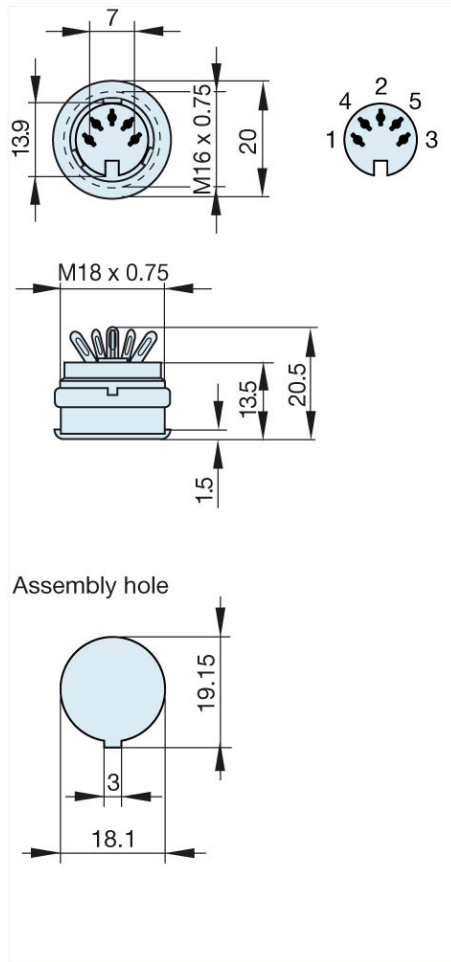

Belden Deutschland GmbH
 Im Gewerbepark 2
 58579 Schalksmühle
 Germany
 Phone: +49 7127/14-1806
 E-Mail: icos-sales@belden.com

The information published in the websites has been compiled as carefully as possible. It is subject to alteration without notice in technical as well as in price-related/commercial respect.



HIRSCHMANN

A **BELDEN** BRAND

The complete information and data were available on user documentation. Mandatory information can only be obtained by a concrete query.