



MAK 7100 S grau/grey

Industrial Connectors:Connectors for audio, video and data:Miniature multipole connectors:with locking screw:Straight sockets

Product description

Type	MAK 7100 S grau/grey
Order No.	930 682-517
Type of contact	female
Description	socket with locking screw; solder joint
Housing Color	grey
Number of contacts	7
Conductor size	$\leq 0.34 \text{ mm}^2$

Drawing

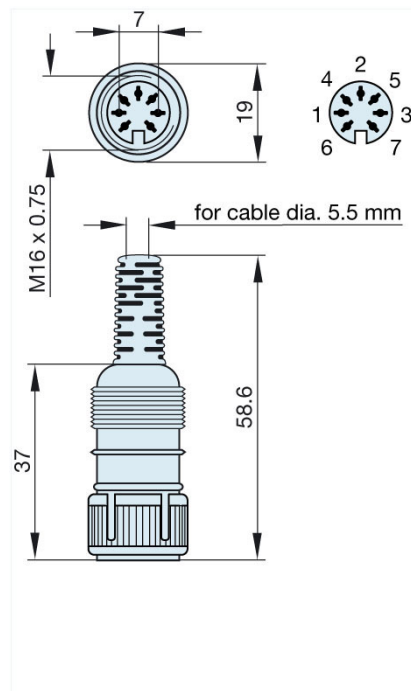

Technical data

LF output "Phone"	EN 60 130-09
Pole arrangement DIN	DIN 45 329
Rated current	4 A
Rated voltage	AC/DC 34 V
Cable diameter	5.5 mm
Type of termination	solder

Material

Contact material (socket)	brass
Contact surface material	tin plated
Contact bearer material	PA 66/UL standard 94V-2

Housing material	PE
Environmental conditions	
Protection class (IEC 60529)	IP 30
Temperature range	-20 °C to +60 °C
Scope of delivery and accessories	
Packaging	retail package, polyethylene bag