

UF15A Series

Size : 172 x 150 x 38

Unit : mm

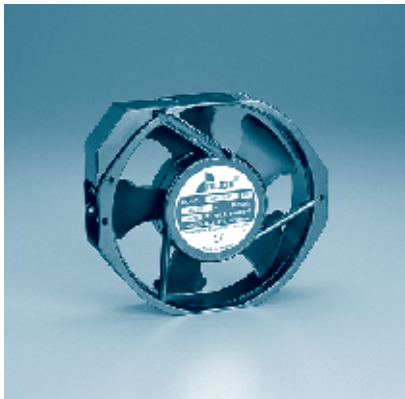

Impedance Protection

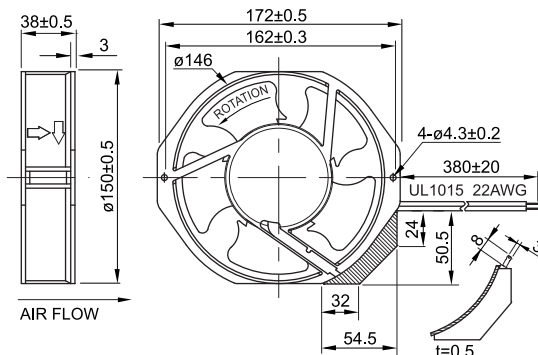

Terminal or Lead Wire Type

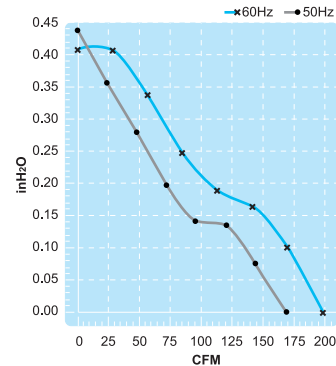

Spec. Model	Rated Voltage V	Frequency Hz	Input Power W	Rated Current A	Locked Current A	Speed RPM	Maximum Air Flow m ³ /min.	Maximum Air Flow CFM	Maximum Pressure mmH ₂ O	Maximum Pressure InchH ₂ O	Noise dB	Weight kg
UF15A11-H	115V	50	36	0.50	0.660	2750	4.7	166	11	0.43	50	0.78
		60	30	0.38	0.560	3200	5.6	198	10	0.40	55	
UF15A23-H	230V	50	37	0.25	0.320	2750	4.7	166	11	0.43	50	0.78
		60	31	0.19	0.280	3200	5.6	198	10	0.40	55	

