

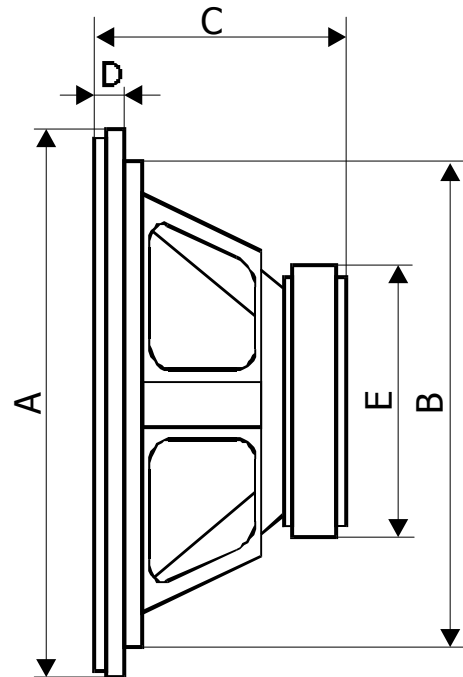

SBX 3040



A	Külső átmérő Diameter Durchmesser	304 mm
B	Beépítési átmérő Mounting cutout Einbauöffnung	282 mm
C	Beépítési mélység Mounting depth Einbautiefe	140 mm
D	Perem vastagság Edge width Randstreifen	10 mm
E	Mágnes átmérő Magnet diameter Magnetdurchmesser	140 mm