

REV.	DESCRIPTION	DRAWN	CHECKED	APPROVED
A	NEW RELEASE	LJH 07/28/05'		

NOTES:

1. SPECIFICATIONS:

- 1.0 VOLTAGE RATING: 30V DC.
- 1.1 CONTACT CURRENT RATING: 1.5A MAX. PER PIN.
- 1.2 CONTACT RESISTANCE: 30 mΩ MAX.
- 1.3 DIELECTRIC WITHSTANDING VOLTAGE:  
500V AC FOR 1 MINUTE.
- 1.4 INSULATION RESISTANCE: 1000MΩ MIN.
- 1.5 OPERATING TEMPERATURE: -40°C ~ +105°C.

2. PRODUCT NUMBER CODE:

DS1107 - X X X

CONTACT PLATED:

- 0: Selective Gold Flash
- C: 3u" Gold
- 3: 30u" Gold

SHELL PLATED:

- N: Nickel
- 6: Tin

COLOR OF HOUSING:

- W: WHITE
- B: BLACK

PRODUCTS SERIES:

DS1107

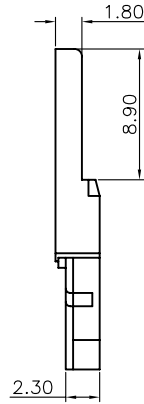
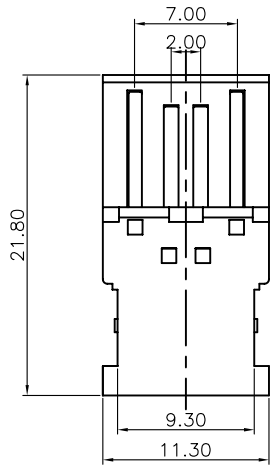
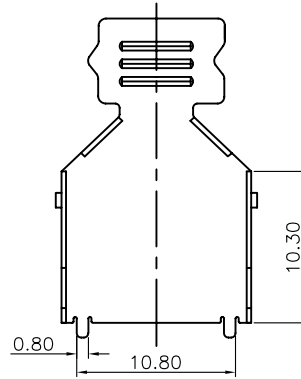
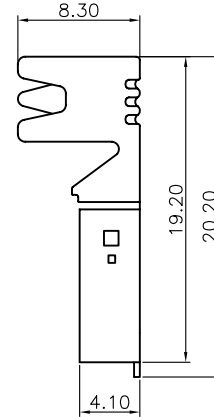
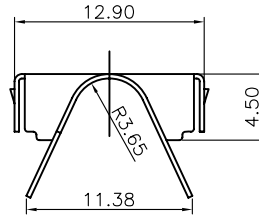
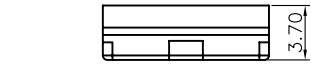

Housing with contact

Upper shell

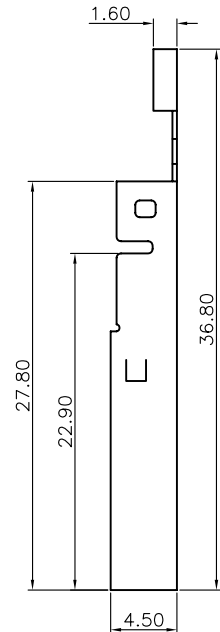
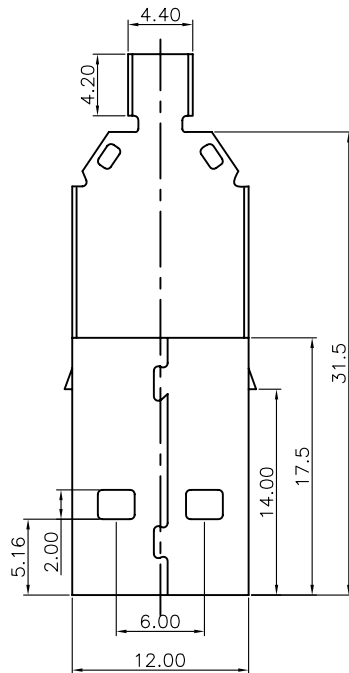

Down shell

GENERAL TOLERANCE		ANGLE TOLERANCE	
X.	±0.60	X.	±5°
.X	±0.38	.X	±3°
.XX	±0.25	.XX	±2°

PROJECTION		TITLE	USB PLUG A TYPE SOLDER TYPE
UNITS	mm	SHEET	1 OF 1
SHEET SIZE	A4	SERIES	DS1107

DRAWING TYPE	CUSTOMER		
SCALE	1:1	SHEET	1 OF 1
DRAWING NO.	C-DS1107-XXX		

**晨翔电子有限公司**  
**CONNFLY® CONNFLY ELECTRONIC CO., LTD**