



	DIN EN 61558-2-6	VDE	119359
	DIN EN 60 335-1	VDE	102961/84814
	UL 5085-3	UL	on request
	UL 5085-1	UL	E98173
	C22.2	CSA	on request



- according to REACH regulation
- according to RoHs regulation

- Output Power up to 6.0 VA
- Non short-circuit-proof at temperature class ta 70°C/B
- Standard type cast housing “K” and “O”
- Excellent temperature fluctuation resistance properties
- High electrical safety and long service life features
- High voltage resistance
- Self-extinguishing cast housing and sealing material
- Per item tested quality with certificate

Protection extern secondary by:

- Micro fuse according to IEC 127 or
- PTC resistance

Connection scheme (only connected pins are present)

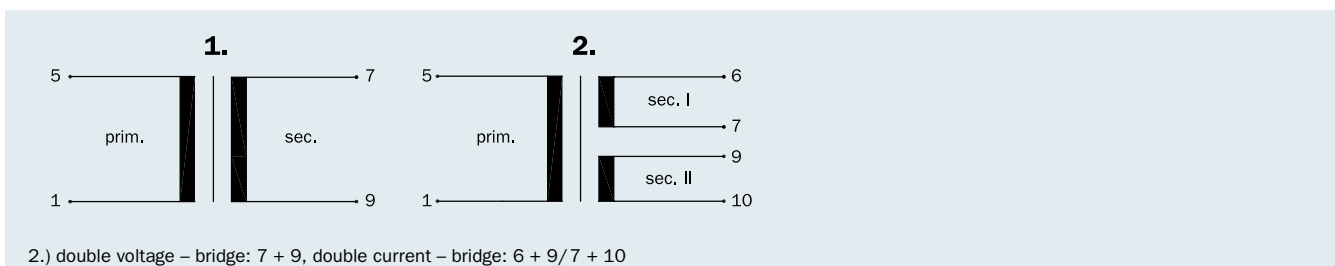

Frame size/Core height	Output Power ta 70°C/B	Height (h)	Weight	Packaging unit
BV EI 422 /14.8 mm	6.0 VA	32.3 mm	0.200 kg	40/50 pieces*

* it depends on kind of cast housing

Connecting pins type cast housing "0"

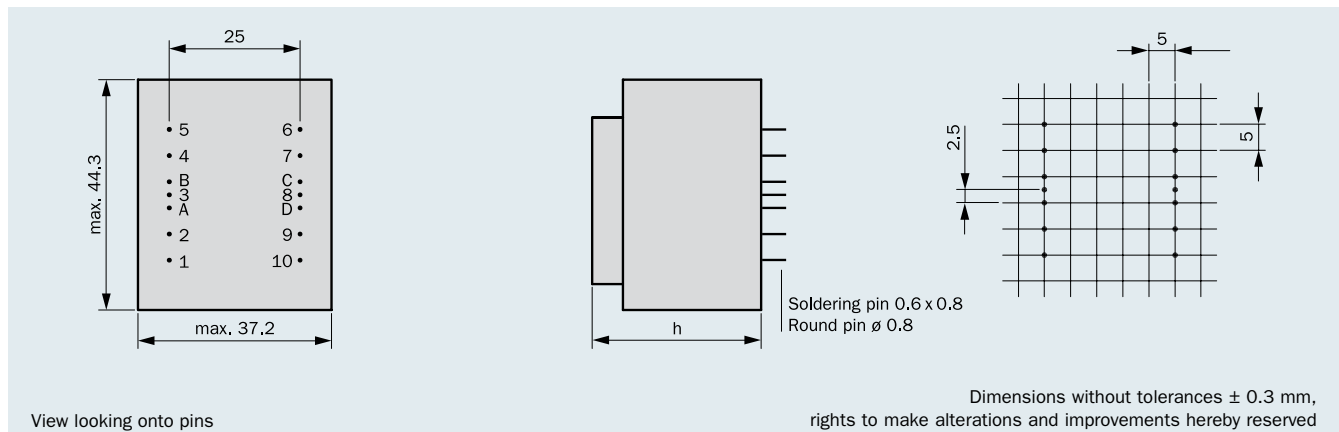

Type cast housing "0"

Order No.	Primary voltage V	Connecting pins prim.	Secondary voltage V	Current sec. mA	Connecting pins sec.	No-load voltage V	Connection scheme
BV EI 422 1320	230	1 - 5	1 x 6	1000	7-9	1 x 8.7	1
BV EI 422 1298	230	1 - 5	2 x 6	500	6-7/9-10	2 x 8.7	2
BV EI 422 1303	230	1 - 5	1 x 7.5	800	7-9	1 x 10.9	1
BV EI 422 1304	230	1 - 5	2 x 7.5	400	6-7/9-10	2 x 10.9	2
BV EI 422 1285	230	1 - 5	1 x 9	667	7-9	1 x 13.0	1
BV EI 422 1281	230	1 - 5	2 x 9	334	6-7/9-10	2 x 13.0	2
BV EI 422 1275	230	1 - 5	1 x 12	500	7-9	1 x 16.7	1
BV EI 422 1260	230	1 - 5	2 x 12	250	6-7/9-10	2 x 16.7	2
BV EI 422 1276	230	1 - 5	1 x 15	400	7-9	1 x 20.2	1
BV EI 422 1305	230	1 - 5	2 x 15	200	6-7/9-10	2 x 20.6	2
BV EI 422 1289	230	1 - 5	1 x 18	334	7-9	1 x 24.6	1
BV EI 422 1306	230	1 - 5	2 x 18	167	6-7/9-10	2 x 24.6	2
BV EI 422 1355	230	1 - 5	1 x 21	285	7-9	1 x 27.1	1
BV EI 422 1307	230	1 - 5	1 x 24	250	7-9	1 x 30.8	1

6.0 VA
ta 70°C/B

Frame size/Core height
BV EI 422 /
14.8 mm

non short-circuit-proof







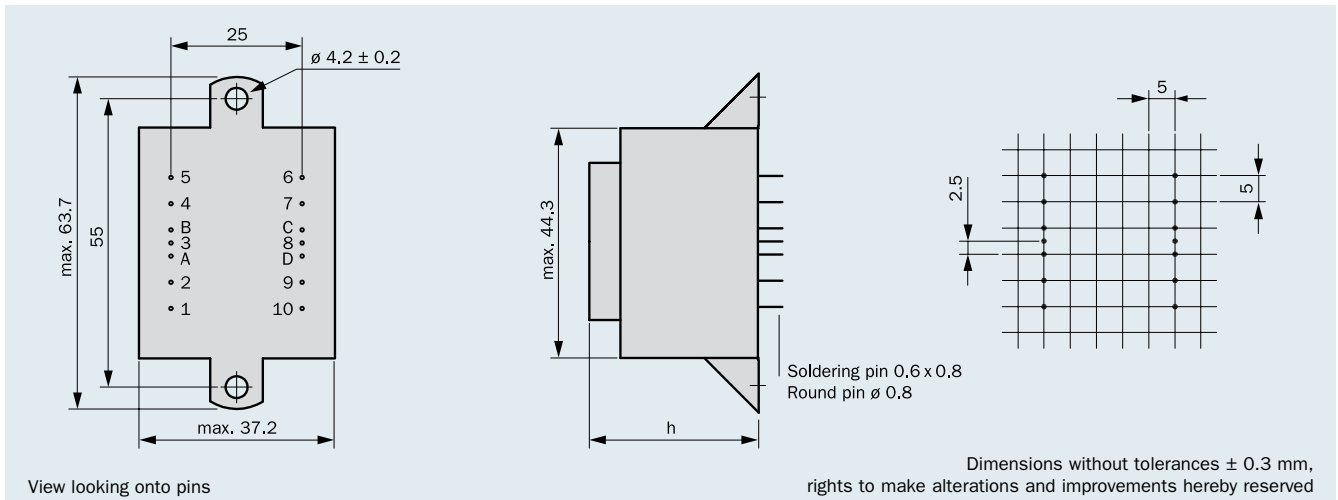

no load power loss
type. 1.3 W

Connecting pins type cast housing "K" with 2 fixing straps



Type cast housing **"K"**

6.0 VA ta 70°C/B	Order No.	Primary voltage V	Connecting pins prim.	Secondary voltage V	Current sec. mA	Connecting pins sec.	No-load voltage V	Connection scheme	
Frame size/Core height BV EI 422.... / 14.8 mm	BV EI 422 1218	230	1 - 5	1 x 6	1000	7-9	1 x 8.7	1	
	BV EI 422 1219	230	1 - 5	2 x 6	500	6-7/9-10	2 x 8.7	2	
	BV EI 422 1220	230	1 - 5	1 x 7.5	800	7-9	1 x 10.9	1	
	BV EI 422 1221	230	1 - 5	2 x 7.5	400	6-7/9-10	2 x 10.9	2	
	non short-circuit-proof 	BV EI 422 1222	230	1 - 5	1 x 9	667	7-9	1 x 13.0	1
		BV EI 422 1223	230	1 - 5	2 x 9	334	6-7/9-10	2 x 13.0	2
	no load power loss type. 1.3 W	BV EI 422 1224	230	1 - 5	1 x 12	500	7-9	1 x 16.7	1
		BV EI 422 1225	230	1 - 5	2 x 12	250	6-7/9-10	2 x 16.7	2
		BV EI 422 1226	230	1 - 5	1 x 15	400	7-9	1 x 20.2	1
		BV EI 422 1227	230	1 - 5	2 x 15	200	6-7/9-10	2 x 20.6	2
		BV EI 422 1228	230	1 - 5	1 x 18	334	7-9	1 x 24.6	1
		BV EI 422 1229	230	1 - 5	2 x 18	167	6-7/9-10	2 x 24.6	2
	BV EI 422 1354	230	1 - 5	1 x 21	285	7-9	1 x 27.1	1	
	BV EI 422 1230	230	1 - 5	1 x 24	250	7-9	1 x 30.8	1	

	DIN EN 61558-2-6	VDE	on request
	DIN EN 60 335-1	VDE	on request
	UL 5085-3	UL	on request
	UL 5085-1	UL	on request
	C22.2	CSA	on request

Individual version!

Parallel to the cataloged EI 42 series transformers, HAHN also produces other variants, e.g. with integrated thermo fuse or thermo switch, other housing-, fixing- and connective options as well as non-encapsulated transformers.

- according to REACH regulation
- according to RoHs regulation

Frame size/Core height	Output Power ta 70°C/B	Height (h)	Weight	Packaging unit
BV EI 421 / 8.5 mm	3.0 VA	26.2 mm	0.120 kg	40/50 pieces**
BV EI 422 /14.8 mm	6.0 VA	32.3 mm	0.200 kg	40/50 pieces**
BV EI 423 /20.0 mm*	10.0 VA	38.0 mm	0.250 kg	50 pieces

* only type cast housing "0"

** it depends on kind of cast housing

Connecting pins type cast housing "0"

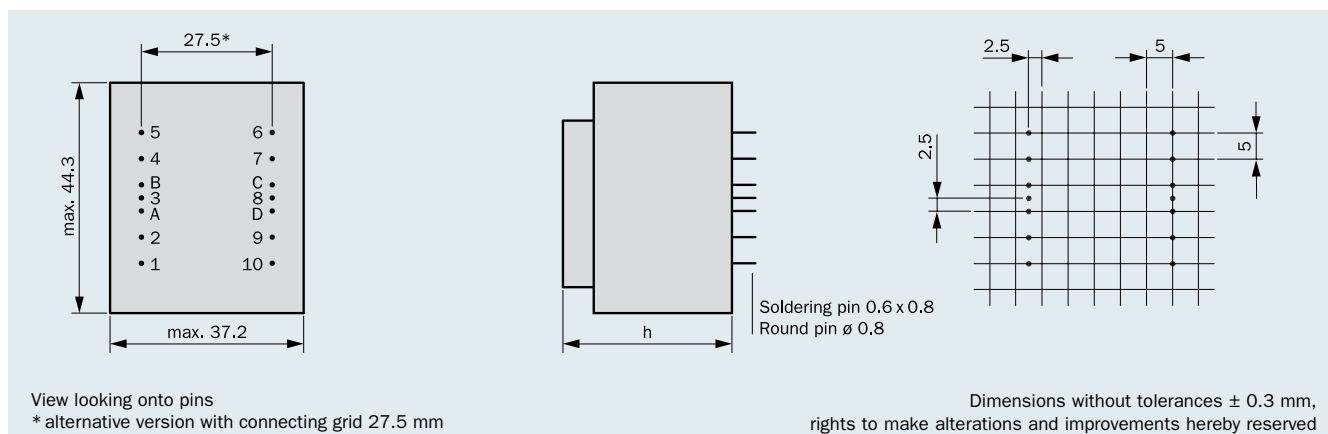

Connecting pins type cast housing "0" with fixing band

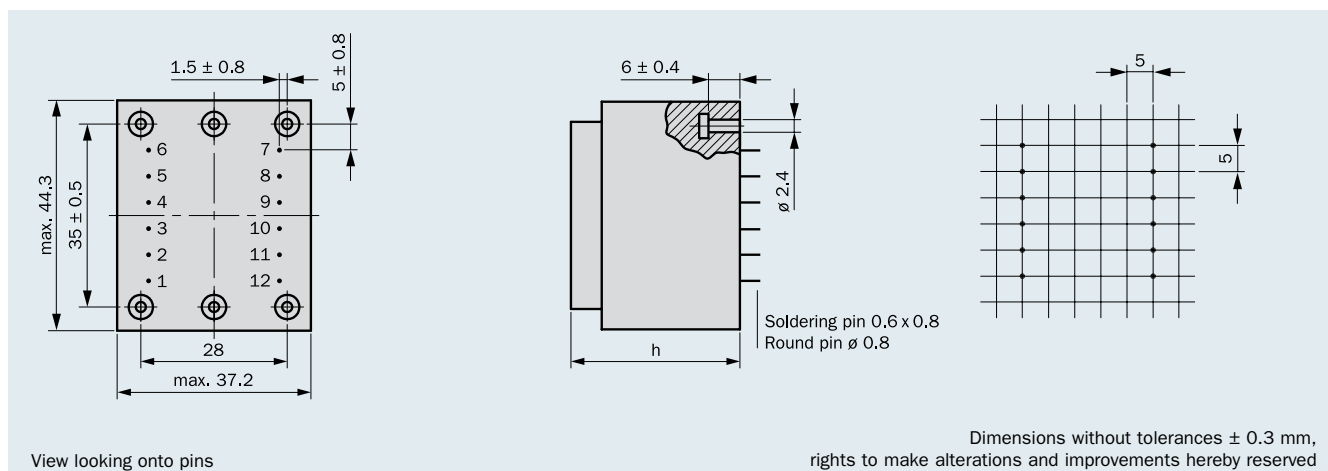

Connecting pins type cast housing "SV" for upright mounting

