

REV.	DESCRIPTION	DRAWN	CHECKED	APPROVED
A	NEW RELEASE	DGQ 06/14/11'		

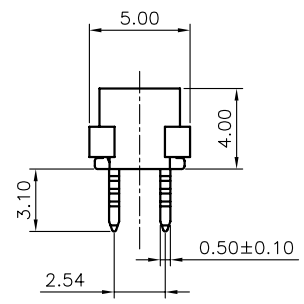
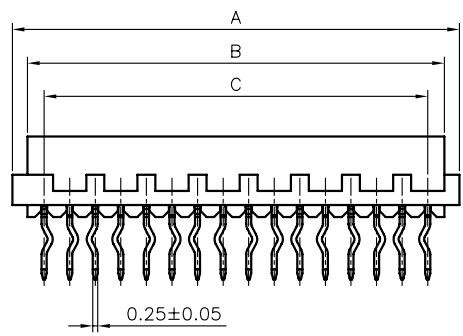
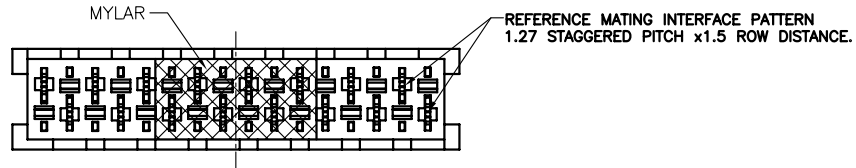

NOTES:

- MATERIAL
 - INSULATOR:THERMOPLASTIC(UL 94V-0).
 - CONTACT: 0.25t COPPER ALLOY.
- SPECIFICATION
 - TEMPERATURE RANGE:-40°C~+105°C.
 - CONTACT RESISTANCE:30mΩ max.
 - INSULATION RESISTANCE:1000MΩ min.
 - DIELECTRIC WITHSTANDING VOLTAGE:AC 500V PER MINUTE.

3. PRODUCT NUMBER CODE:

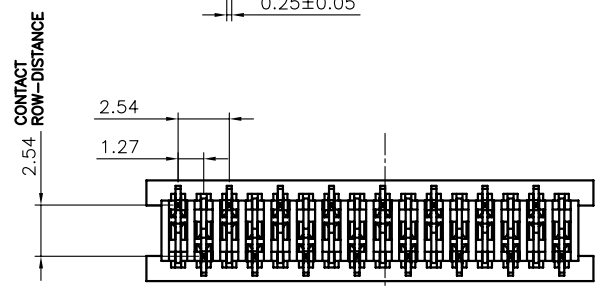
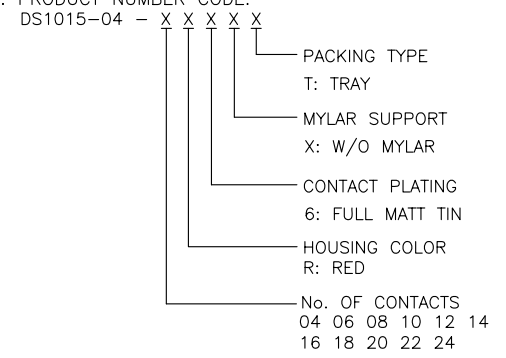

POSITIONS	DIM A	DIM B	DIM C
4	6.96	5.46	3.81
6	9.50	8.00	6.35
8	12.04	10.54	8.89
10	14.58	13.08	11.43
12	17.12	15.62	13.97
14	19.66	18.16	16.51
16	22.20	20.70	19.05
18	24.74	23.24	21.59
20	27.28	25.78	24.13
22	29.82	28.32	26.67
24	32.36	30.86	29.21

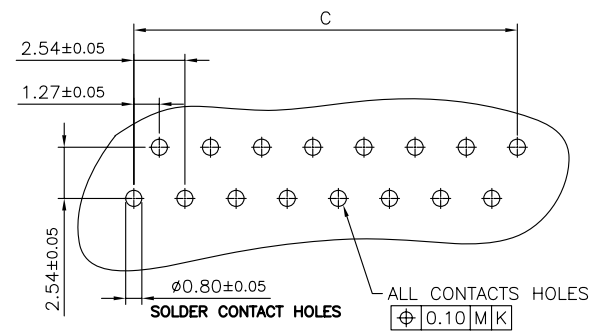
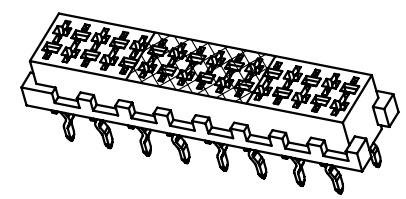

GENERAL TOLERANCE	ANGLE TOLERANCE	PROJECTION	⊕ - ▽	TITLE	MICRO MATCH FEMALE VERTICAL THROUGH HOLE TYPE
X. ±0.60	X. ±5°	UNITS	mm	SHEET	DS1015-04 SERIES
.X ±0.38	.X ±3°	SHEET SIZE	A4		
.XX ±0.25	.XX ±2°				
DRAWING TYPE	CUSTOMER				
SCALE	1:1	SHEET	1 OF 1		
DRAWING NO.	C-DS1015-04-XXXX-A				
		晨翔电子有限公司 CONNFLY ELECTRONIC CO., LTD			