

60 A, 650 V field stop trench gate IGBT with Ultrafast diode

Datasheet - production data

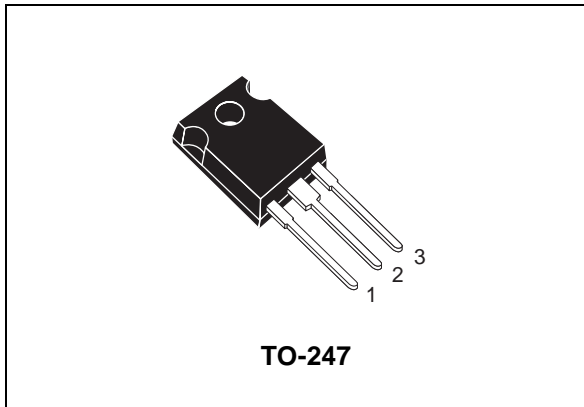
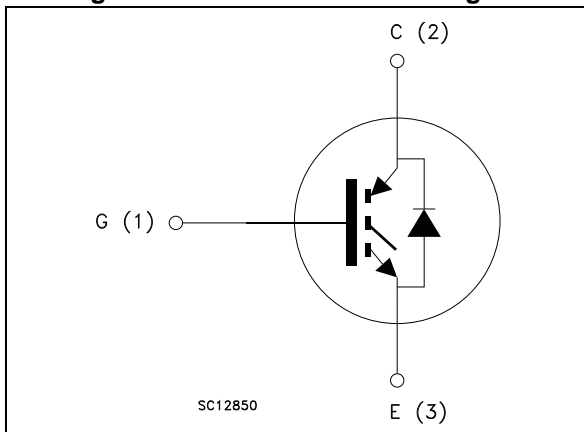

Figure 1. Internal schematic diagram



Applications

- Photovoltaic inverters
- Uninterruptible power supply
- Welding
- Power factor correction
- High switching frequency converters

Description

This device is an IGBT developed using an advanced proprietary trench gate and field stop structure. This IGBT is the result of a compromise between conduction and switching losses, maximizing the efficiency of high switching frequency converters. Furthermore, a slightly positive $V_{CE(sat)}$ temperature coefficient and very tight parameter distribution result in easier paralleling operation.

Features

- Very high speed switching
- Tight parameters distribution
- Safe paralleling
- Low thermal resistance
- 6 μ s short-circuit withstand time
- Ultrafast soft recovery antiparallel diode

Table 1. Device summary

Order code	Marking	Package	Packaging
STGW60H65DRF	GW60H65DRF	TO-247	Tube

1 Electrical ratings

Table 2. Absolute maximum ratings

Symbol	Parameter	Value	Unit
V_{CES}	Collector-emitter voltage ($V_{GE} = 0$)	650	V
I_C	Continuous collector current at $T_C = 25\text{ °C}$	120	A
I_C	Continuous collector current at $T_C = 100\text{ °C}$	60	A
$I_{CP}^{(1)}$	Pulsed collector current	240	A
V_{GE}	Gate-emitter voltage	± 20	V
I_F	Continuous forward current at $T_C = 25\text{ °C}$	120	A
	Continuous forward current at $T_C = 100\text{ °C}$	60	
$I_{FP}^{(1)}$	Pulsed forward current	240	A
P_{TOT}	Total dissipation at $T_C = 25\text{ °C}$	420	W
t_{SC}	Short-circuit withstand time at $V_{CC} = 400\text{ V}$, $V_{GE} = 15\text{ V}$	6	μs
T_{STG}	Storage temperature range	- 55 to 175	$^{\circ}\text{C}$
T_J	Operating junction temperature		

1. Pulse width limited by maximum junction temperature and turn-off within RBSOA.

Table 3. Thermal data

Symbol	Parameter	Value	Unit
R_{thJC}	Thermal resistance junction-case IGBT	0.35	$^{\circ}\text{C}/\text{W}$
R_{thJC}	Thermal resistance junction-case diode	1.38	$^{\circ}\text{C}/\text{W}$
R_{thJA}	Thermal resistance junction-ambient	50	$^{\circ}\text{C}/\text{W}$

2 Electrical characteristics

$T_J = 25\text{ °C}$ unless otherwise specified.

Table 4. Static

Symbol	Parameter	Test conditions	Min.	Typ.	Max.	Unit
$V_{(BR)CES}$	Collector-emitter breakdown voltage ($V_{GE} = 0$)	$I_C = 2\text{ mA}$	650			V
$V_{CE(sat)}$	Collector-emitter saturation voltage	$V_{GE} = 15\text{ V}, I_C = 60\text{ A}$		1.9	2.4	V
		$V_{GE} = 15\text{ V}, I_C = 60\text{ A}$ $T_J = 125\text{ °C}$		2.1		
$V_{GE(th)}$	Gate threshold voltage	$V_{CE} = V_{GE}, I_C = 1\text{ mA}$		6.0		V
I_{CES}	Collector cut-off current ($V_{GE} = 0$)	$V_{CE} = 650\text{ V}$			25	μA
I_{GES}	Gate-emitter leakage current ($V_{CE} = 0$)	$V_{GE} = \pm 20\text{ V}$			250	nA

Table 5. Dynamic

Symbol	Parameter	Test conditions	Min.	Typ.	Max.	Unit
C_{ies}	Input capacitance	$V_{CE} = 25\text{ V}, f = 1\text{ MHz},$ $V_{GE} = 0$	-	7150	-	pF
C_{oes}	Output capacitance			275		
C_{res}	Reverse transfer capacitance			140		
Q_g	Total gate charge	$V_{CC} = 400\text{ V}, I_C = 60\text{ A},$ $V_{GE} = 15\text{ V}$	-	217	-	nC
Q_{ge}	Gate-emitter charge			67		
Q_{gc}	Gate-collector charge			97		

Table 6. Switching on/off (inductive load)

Symbol	Parameter	Test conditions	Min.	Typ.	Max.	Unit
$t_{d(on)}$	Turn-on delay time	$V_{CE} = 400\text{ V}, I_C = 60\text{ A},$ $R_G = 10\ \Omega, V_{GE} = 15\text{ V}$	-	85	-	ns
t_r	Current rise time			33		
$(di/dt)_{on}$	Turn-on current slope			1800		
$t_{d(on)}$	Turn-on delay time	$V_{CE} = 400\text{ V}, I_C = 60\text{ A},$ $R_G = 10\ \Omega, V_{GE} = 15\text{ V}$ $T_J = 125\text{ °C}$	-	82	-	ns
t_r	Current rise time			35		
$(di/dt)_{on}$	Turn-on current slope			1680		
$t_{r(Voff)}$	Off voltage rise time	$V_{CE} = 400\text{ V}, I_C = 60\text{ A},$ $R_G = 10\ \Omega, V_{GE} = 15\text{ V}$	-	34	-	ns
$t_{d(off)}$	Turn-off delay time			178		
t_f	Current fall time			30		
$t_{r(Voff)}$	Off voltage rise time	$V_{CE} = 400\text{ V}, I_C = 60\text{ A},$ $R_G = 10\ \Omega, V_{GE} = 15\text{ V}$ $T_J = 125\text{ °C}$	-	45	-	ns
$t_{d(off)}$	Turn-off delay time			205		
t_f	Current fall time			70		

Table 7. Switching energy (inductive load)

Symbol	Parameter	Test conditions	Min.	Typ.	Max.	Unit
$E_{on}^{(1)}$	Turn-on switching losses	$V_{CE} = 400\text{ V}$, $I_C = 60\text{ A}$, $R_G = 10\ \Omega$, $V_{GE} = 15\text{ V}$	-	0.94	-	mJ
$E_{off}^{(2)}$	Turn-off switching losses			1.06		mJ
E_{ts}	Total switching losses			2.0		mJ
$E_{on}^{(1)}$	Turn-on switching losses	$V_{CE} = 400\text{ V}$, $I_C = 60\text{ A}$, $R_G = 10\ \Omega$, $V_{GE} = 15\text{ V}$ $T_J = 125\text{ }^\circ\text{C}$	-	1.48	-	mJ
$E_{off}^{(2)}$	Turn-off switching losses			1.4		mJ
E_{ts}	Total switching losses			2.88		mJ

1. E_{on} is the turn-on losses when a typical diode is used in the test circuit in [Figure 23](#). If the IGBT is offered in a package with a co-pack diode, the co-pack diode is used as external diode. IGBTs and diode are at the same temperature (25 °C and 125 °C).
2. Turn-off losses include also the tail of the collector current.

Table 8. Collector-emitter diode

Symbol	Parameter	Test conditions	Min.	Typ.	Max.	Unit
V_F	Forward on-voltage	$I_F = 60\text{ A}$ $I_F = 60\text{ A}$, $T_J = 150\text{ }^\circ\text{C}$	-	3.7	4.8	V
				2.2		V
t_{rr}	Reverse recovery time	$I_F = 60\text{ A}$, $V_R = 400\text{ V}$, $di/dt = 1700\text{ A}/\mu\text{s}$	-	19	-	ns
Q_{rr}	Reverse recovery charge			200		nC
I_{rrm}	Reverse recovery current			15.5		A
t_{rr}	Reverse recovery time	$I_F = 60\text{ A}$, $V_R = 400\text{ V}$, $di/dt = 1630\text{ A}/\mu\text{s}$ $T_J = 125\text{ }^\circ\text{C}$	-	34	-	ns
Q_{rr}	Reverse recovery charge			780		nC
I_{rrm}	Reverse recovery current			46		A

2.1 Electrical characteristics (curves)

Figure 2. Output characteristics ($T_J = -40\text{ }^\circ\text{C}$)

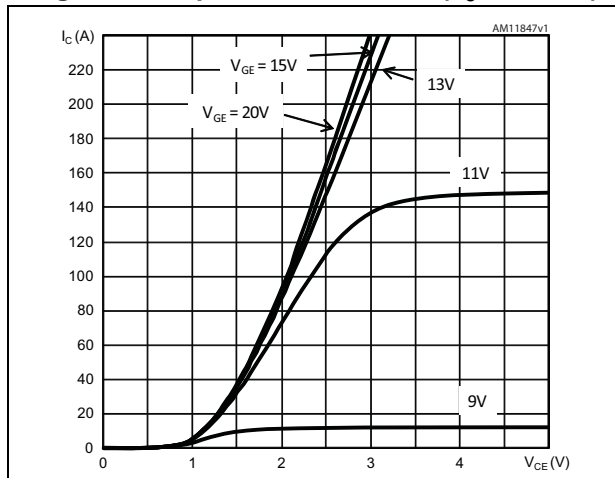

Figure 3. Output characteristics ($T_J = 25\text{ }^\circ\text{C}$)

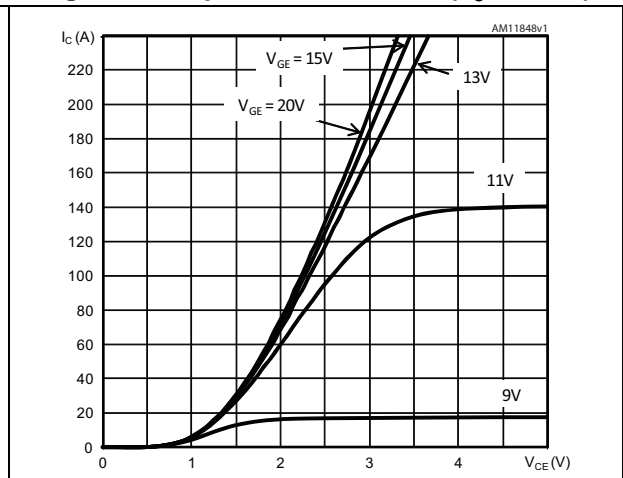

Figure 4. Output characteristics ($T_J = 150\text{ }^\circ\text{C}$)

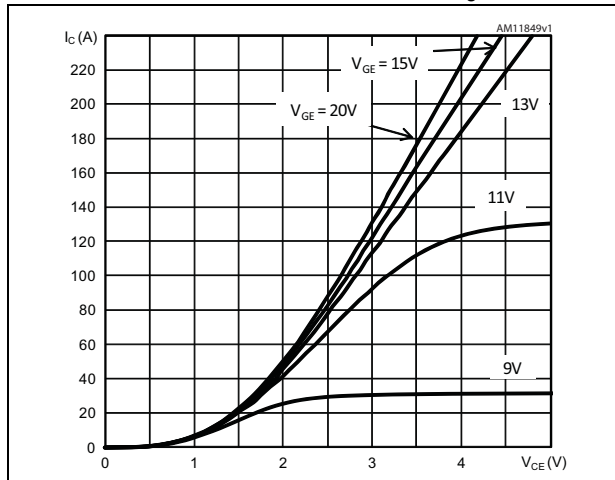

Figure 5. Transfer characteristics

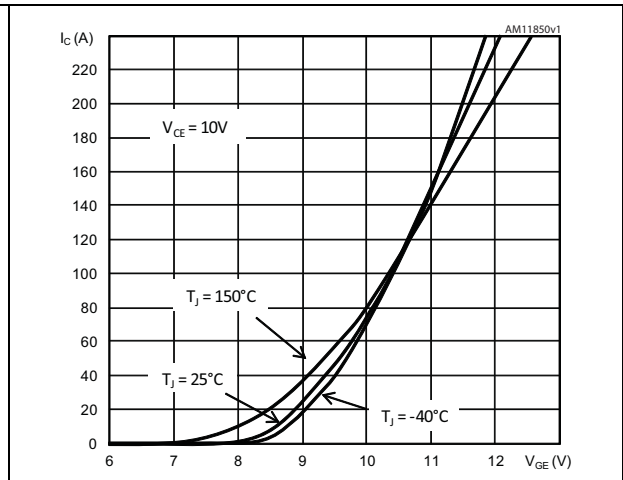

Figure 6. $V_{CE(SAT)}$ vs. junction temperature

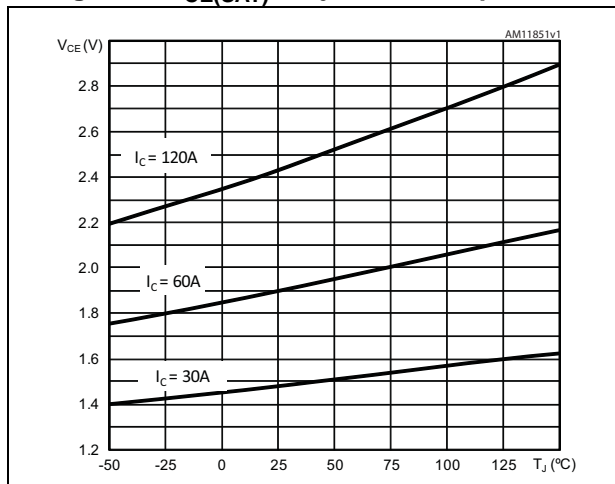

Figure 7. $V_{CE(SAT)}$ vs. collector current

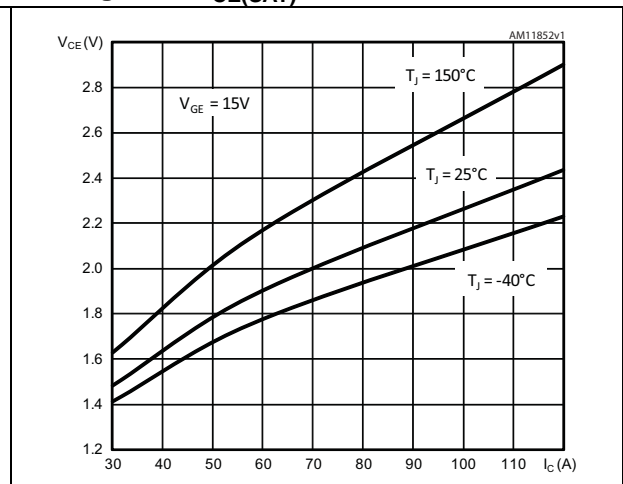

Figure 8. Normalized $V_{GE(th)}$ vs. junction temperature

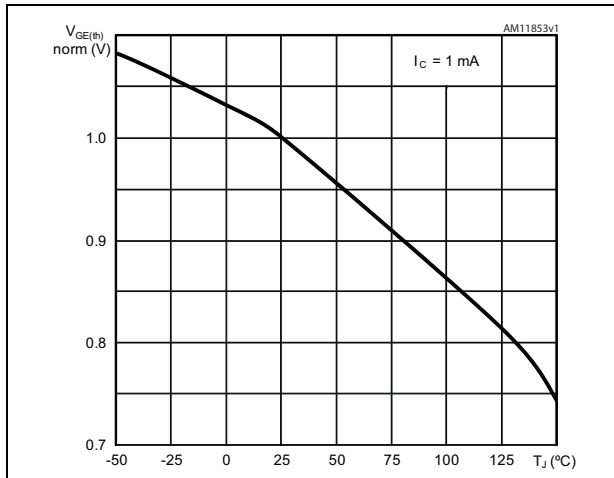

Figure 9. Gate charge vs. gate-emitter voltage

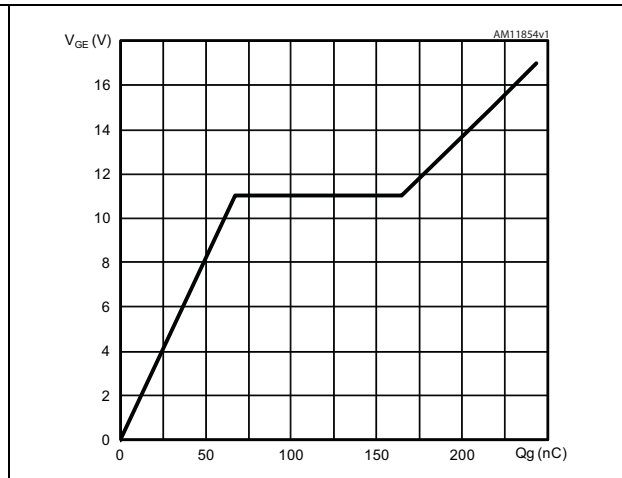

Figure 10. Capacitance variations ($f = 1 \text{ MHz}$, $V_{GE} = 0$)

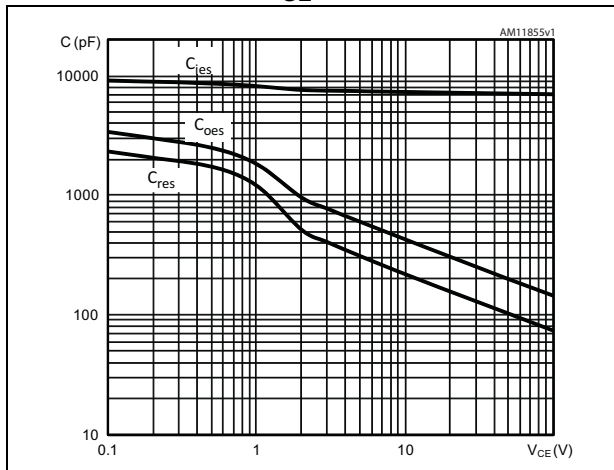

Figure 11. Switching losses vs. collector current

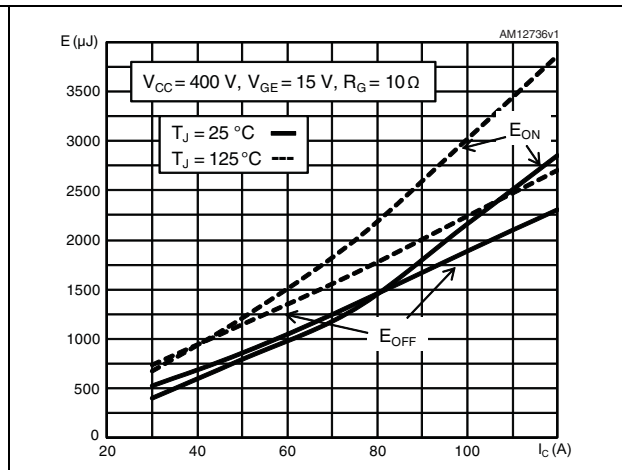

Figure 12. Switching losses vs. gate resistance

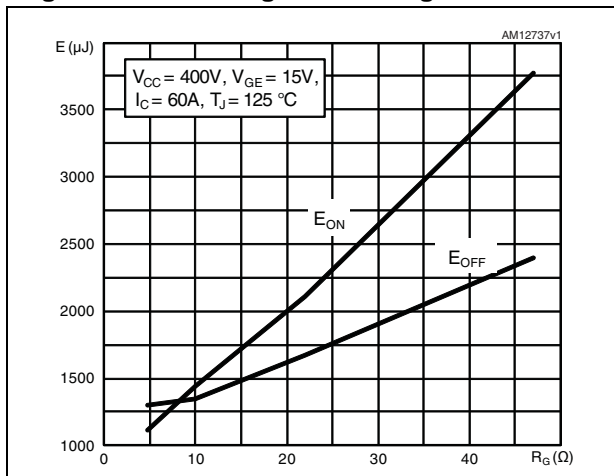

Figure 13. Switching losses vs. temperature

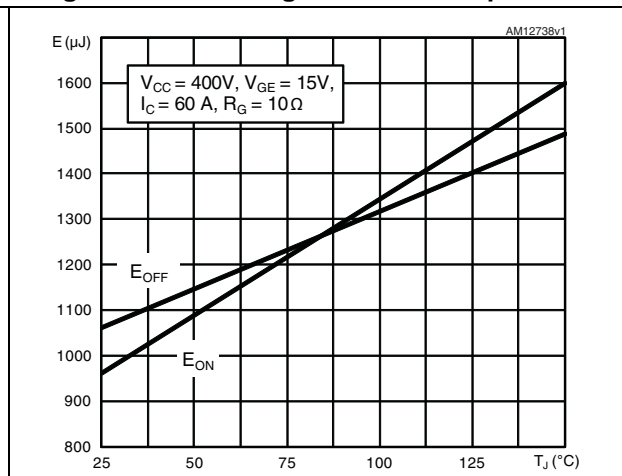

Figure 14. Turn-OFF SOA

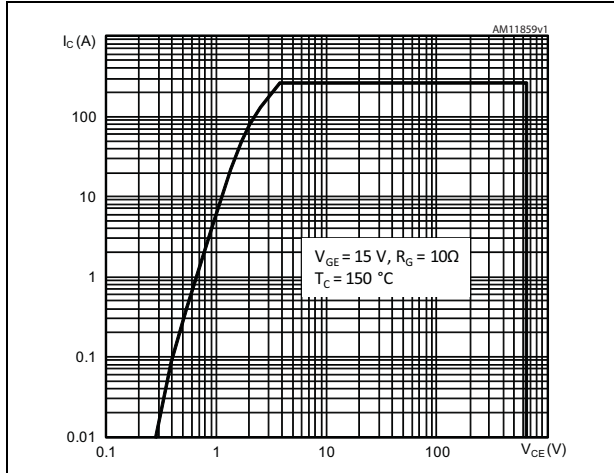

Figure 15. Short circuit time & current vs. V_{GE}

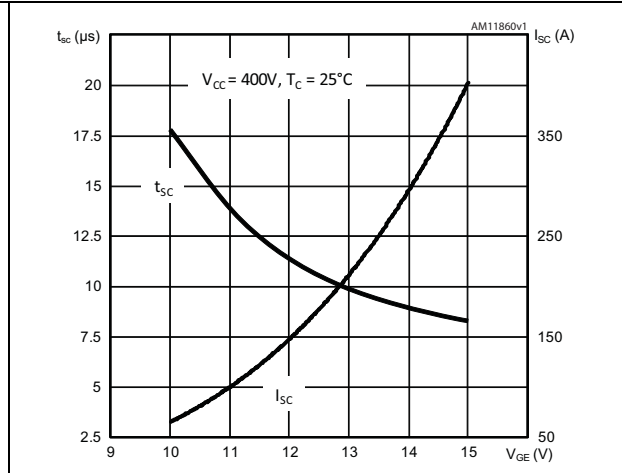

Figure 16. Diode forward current vs. forward voltage

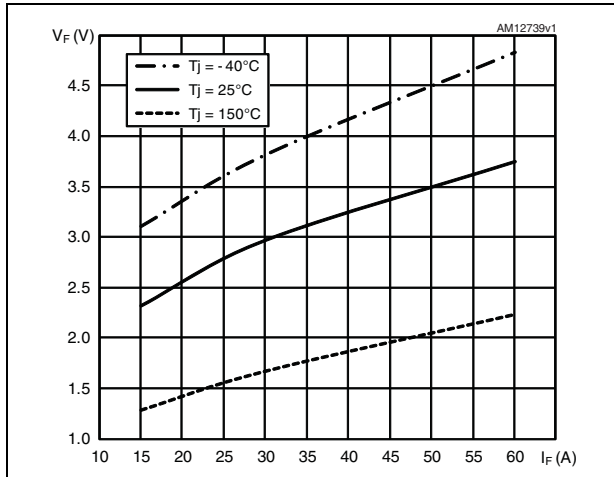

Figure 17. Diode forward current vs. junction temperature

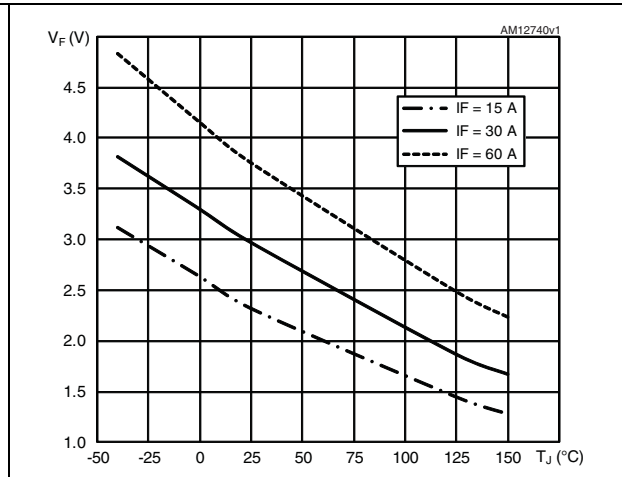

Figure 18. Reverse recovery current as a function of diode current slope

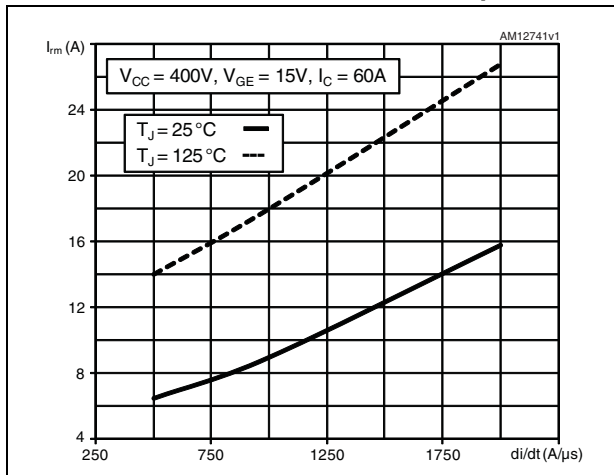

Figure 19. Reverse recovery time as a function of diode current slope

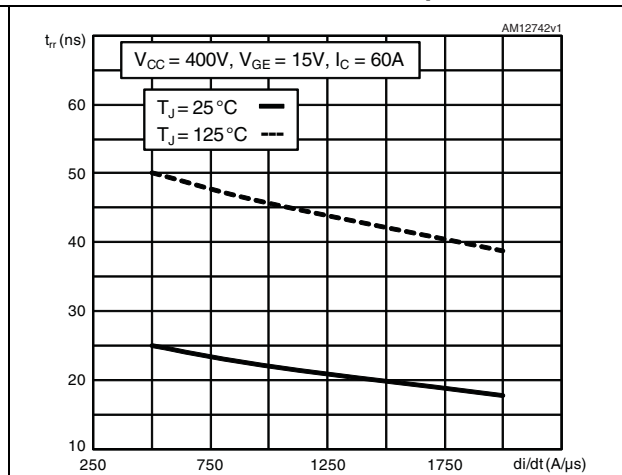

Figure 20. Reverse recovery charge as a function of diode current slope

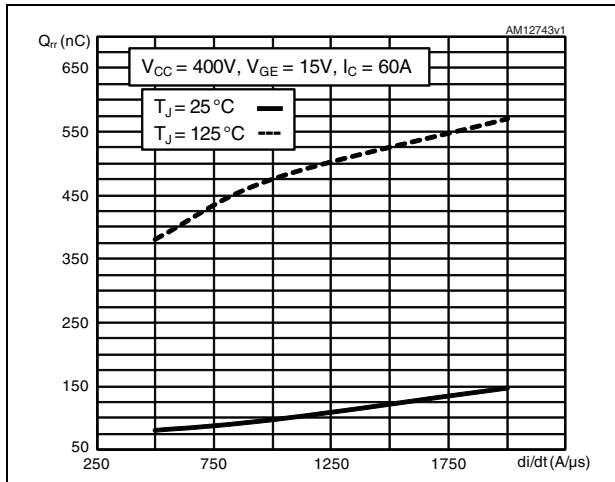

Figure 21. Maximum normalized Z_{th} junction to case (IGBT)

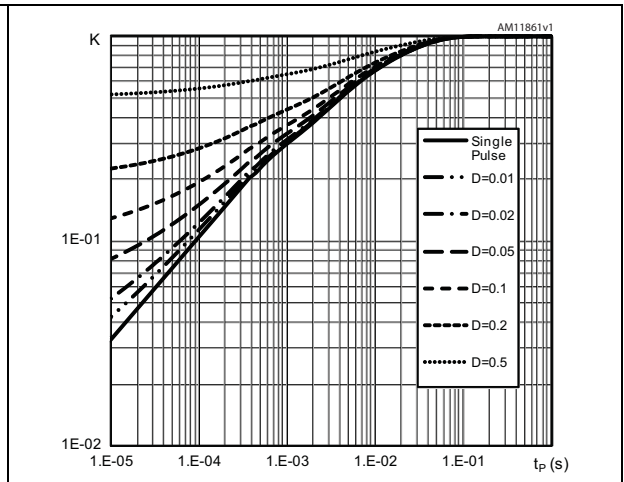
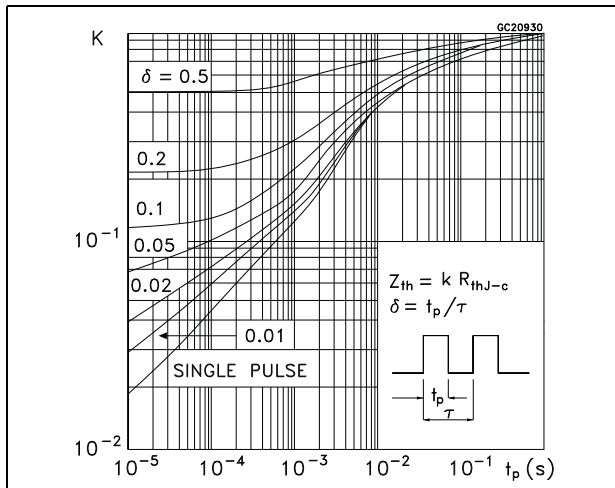

Figure 22. Maximum normalized Z_{th} junction to case (Diode)



3 Test circuits

Figure 23. Test circuit for inductive load switching

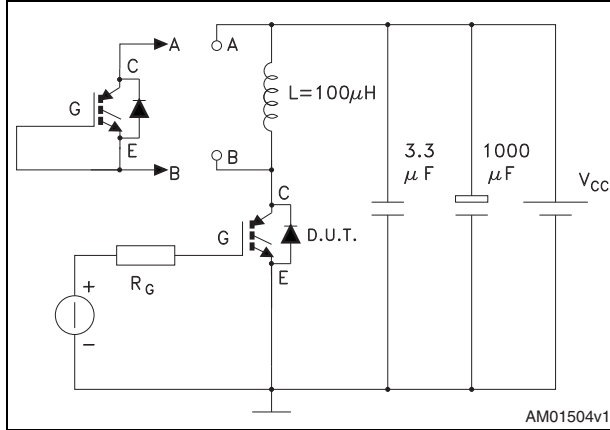

Figure 24. Gate charge test circuit

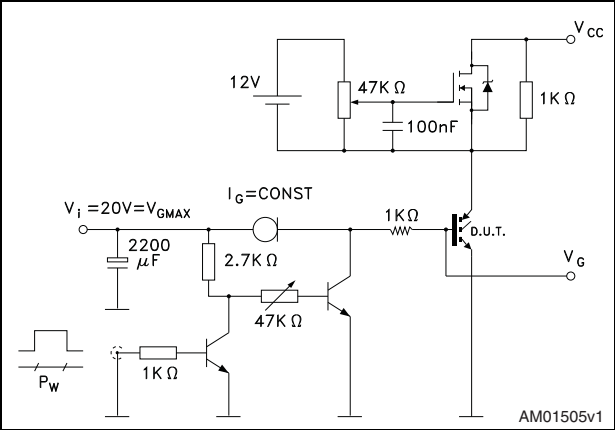

Figure 25. Switching waveform

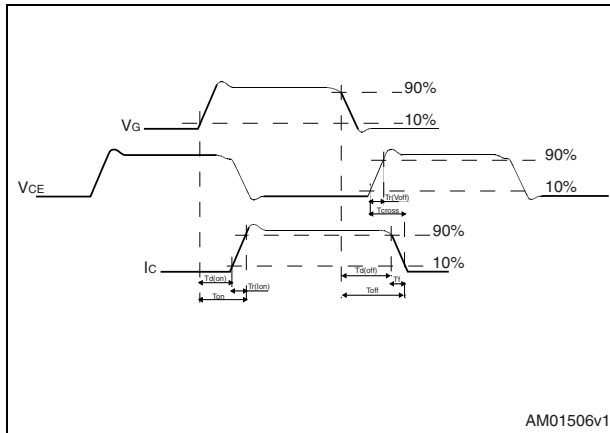
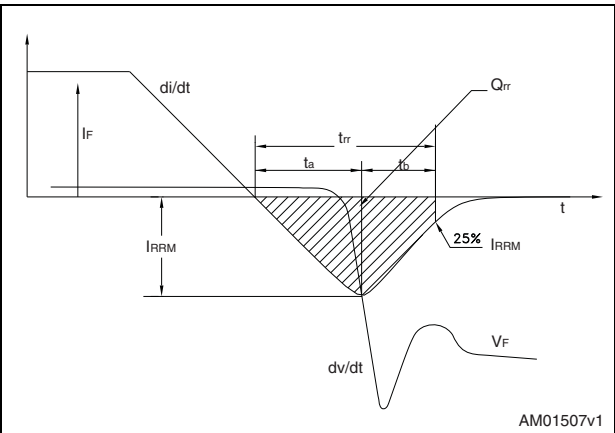

Figure 26. Diode recovery time waveform



4 Package mechanical data

In order to meet environmental requirements, ST offers these devices in different grades of ECOPACK[®] packages, depending on their level of environmental compliance. ECOPACK[®] specifications, grade definitions and product status are available at: www.st.com. ECOPACK[®] is an ST trademark.

Table 9. TO-247 mechanical data

Dim.	mm.		
	Min.	Typ.	Max.
A	4.85		5.15
A1	2.20		2.60
b	1.0		1.40
b1	2.0		2.40
b2	3.0		3.40
c	0.40		0.80
D	19.85		20.15
E	15.45		15.75
e	5.30	5.45	5.60
L	14.20		14.80
L1	3.70		4.30
L2		18.50	
ØP	3.55		3.65
ØR	4.50		5.50
S	5.30	5.50	5.70

Figure 27. TO-247 drawing

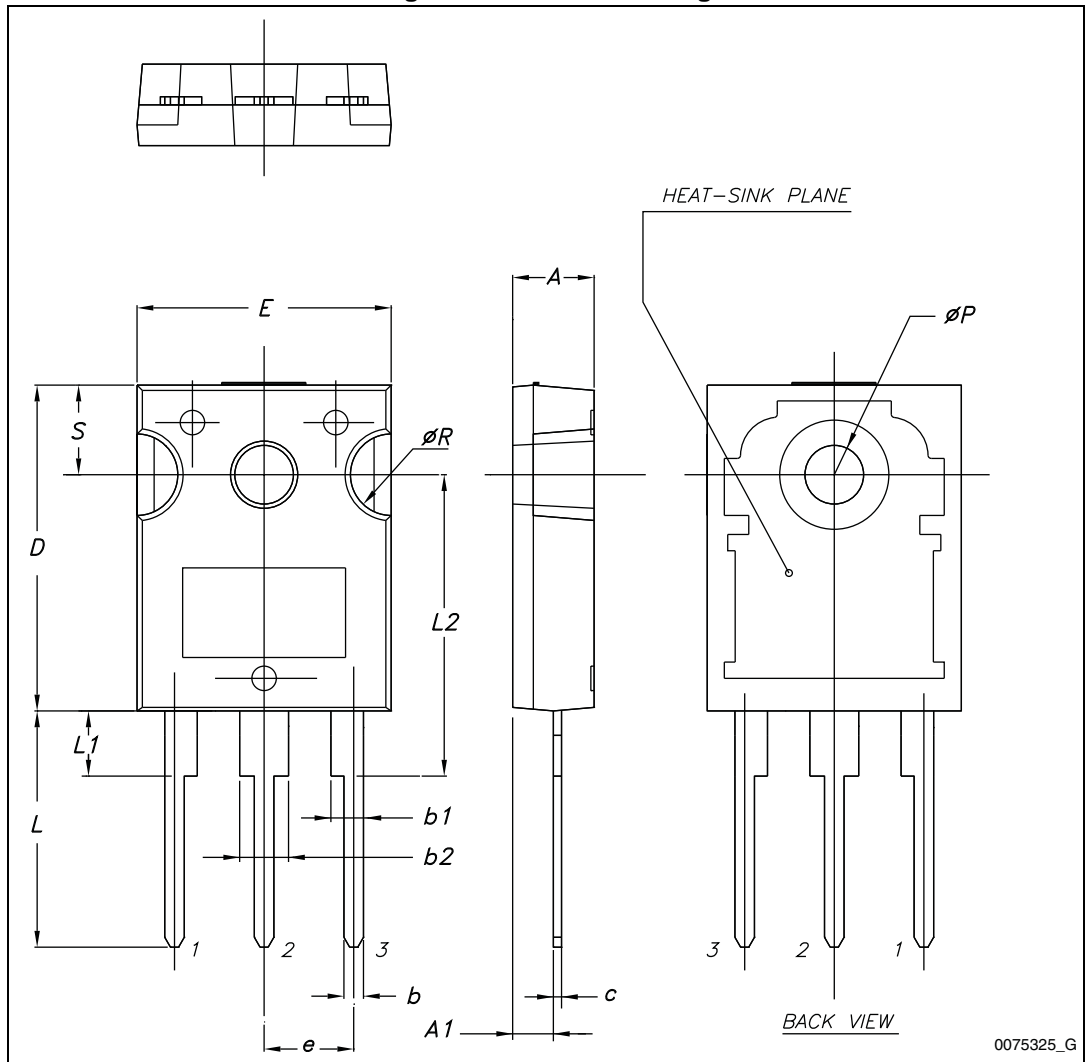

5 Revision history

Table 10. Document revision history

Date	Revision	Changes
11-Oct-2011	1	Initial release.
06-Jun-2012	2	Document status promoted from preliminary data production data. Added: Section 2.1: Electrical characteristics (curves) on page 5.
19-Jun-2012	3	Updated parameters in Table 2.
26-Jul-2012	4	Updated parameters in Table 2.
21-Jan-2013	5	Modified V_F test conditions, typ. and max values Table 8 on page 4.
02-Apr-2013	6	Modified: <ul style="list-style-type: none">– P_{TOT} value Table 2 on page 2.– E_{on} and E_{ts} typical values Table 7 on page 4.

Please Read Carefully:

Information in this document is provided solely in connection with ST products. STMicroelectronics NV and its subsidiaries ("ST") reserve the right to make changes, corrections, modifications or improvements, to this document, and the products and services described herein at any time, without notice.

All ST products are sold pursuant to ST's terms and conditions of sale.

Purchasers are solely responsible for the choice, selection and use of the ST products and services described herein, and ST assumes no liability whatsoever relating to the choice, selection or use of the ST products and services described herein.

No license, express or implied, by estoppel or otherwise, to any intellectual property rights is granted under this document. If any part of this document refers to any third party products or services it shall not be deemed a license grant by ST for the use of such third party products or services, or any intellectual property contained therein or considered as a warranty covering the use in any manner whatsoever of such third party products or services or any intellectual property contained therein.

UNLESS OTHERWISE SET FORTH IN ST'S TERMS AND CONDITIONS OF SALE ST DISCLAIMS ANY EXPRESS OR IMPLIED WARRANTY WITH RESPECT TO THE USE AND/OR SALE OF ST PRODUCTS INCLUDING WITHOUT LIMITATION IMPLIED WARRANTIES OF MERCHANTABILITY, FITNESS FOR A PARTICULAR PURPOSE (AND THEIR EQUIVALENTS UNDER THE LAWS OF ANY JURISDICTION), OR INFRINGEMENT OF ANY PATENT, COPYRIGHT OR OTHER INTELLECTUAL PROPERTY RIGHT.

ST PRODUCTS ARE NOT AUTHORIZED FOR USE IN WEAPONS. NOR ARE ST PRODUCTS DESIGNED OR AUTHORIZED FOR USE IN: (A) SAFETY CRITICAL APPLICATIONS SUCH AS LIFE SUPPORTING, ACTIVE IMPLANTED DEVICES OR SYSTEMS WITH PRODUCT FUNCTIONAL SAFETY REQUIREMENTS; (B) AERONAUTIC APPLICATIONS; (C) AUTOMOTIVE APPLICATIONS OR ENVIRONMENTS, AND/OR (D) AEROSPACE APPLICATIONS OR ENVIRONMENTS. WHERE ST PRODUCTS ARE NOT DESIGNED FOR SUCH USE, THE PURCHASER SHALL USE PRODUCTS AT PURCHASER'S SOLE RISK, EVEN IF ST HAS BEEN INFORMED IN WRITING OF SUCH USAGE, UNLESS A PRODUCT IS EXPRESSLY DESIGNATED BY ST AS BEING INTENDED FOR "AUTOMOTIVE, AUTOMOTIVE SAFETY OR MEDICAL" INDUSTRY DOMAINS ACCORDING TO ST PRODUCT DESIGN SPECIFICATIONS. PRODUCTS FORMALLY ESCC, QML OR JAN QUALIFIED ARE DEEMED SUITABLE FOR USE IN AEROSPACE BY THE CORRESPONDING GOVERNMENTAL AGENCY.

Resale of ST products with provisions different from the statements and/or technical features set forth in this document shall immediately void any warranty granted by ST for the ST product or service described herein and shall not create or extend in any manner whatsoever, any liability of ST.

ST and the ST logo are trademarks or registered trademarks of ST in various countries.

Information in this document supersedes and replaces all information previously supplied.

The ST logo is a registered trademark of STMicroelectronics. All other names are the property of their respective owners.

© 2013 STMicroelectronics - All rights reserved

STMicroelectronics group of companies

Australia - Belgium - Brazil - Canada - China - Czech Republic - Finland - France - Germany - Hong Kong - India - Israel - Italy - Japan - Malaysia - Malta - Morocco - Philippines - Singapore - Spain - Sweden - Switzerland - United Kingdom - United States of America

www.st.com

