

REV.	DESCRIPTION	DRAWN	CHECKED	APPROVED
A	NEW RELEASE	LJH 05/09/05'		

NOTES:

1.SPECIFICATIONS

- .CURRENT RATING: 0.5A/pin Max.
- .VOLTAGE RATING: 30V(DC)
- .DIELECTRIC WITHSTANDING VOLTAGE: 100VAC 1 minute.
- .CONTACT RESISTANCE: 50mΩ Max.
- .INSULATION RESISTANCE: 100MΩ Min
- .TEMPERATURE RANGE: -40°C—+105°C

2.MATERIALS

- .HOUSING: PBT.
- .SHELL: STEEL
- .CONTACT: COPPER ALLOY

3.PRODUCT NUMBER CODE:

DS1105 - X X X X X

Mating Face Type  
1: Type 1  
2: Type 2

Contact plating  
0: Selective gold flash  
C: Selective 3u" gold

Shell plating  
6: Tin  
N: Nickel  
8: Full gold

Color of Hood  
B: BLACK

Color of housing  
B: BLACK

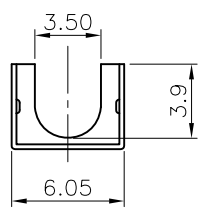
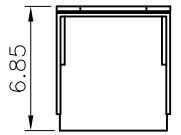
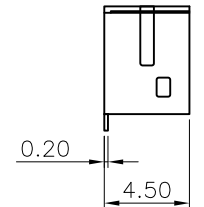
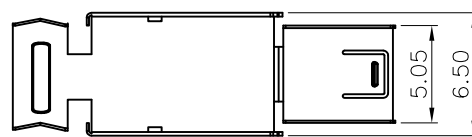
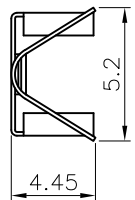
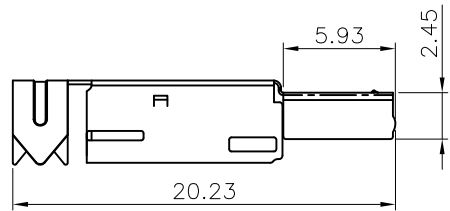
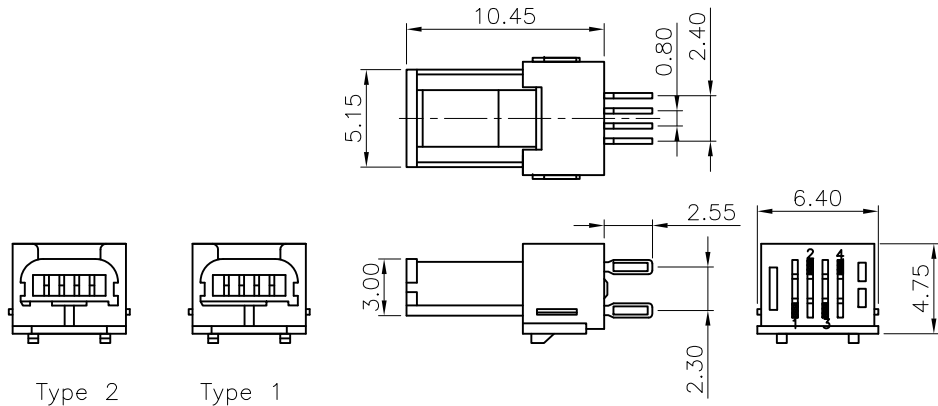

GENERAL TOLERANCE		ANGLE TOLERANCE	
X.	±0.60	X.	±5°
.X	±0.38	.X	±3°
.XX	±0.25	.XX	±2°

PROJECTION	TITLE
UNITS	MINI USB 4PIN A TYPE MALE SOLDER
SHEET SIZE	SERIES DS1105

DRAWING TYPE	CUSTOMER		
SCALE	1:1	SHEET	1 OF 1
DRAWING NO.	C-DS1105-XXX		

 晨翔电子有限公司  
**CONNFLY® CONNFLY ELECTRONIC CO., LTD**