

■ **Features**

- High Luminous LEDs
- 5mm Round Standard Directivity
- Superior Weather-resistance
- Flashing Type
- Water Clear Type

■ **Applications**

- Toys
- Games
- Audio
- Other Lighting

■ **Outline Dimension**

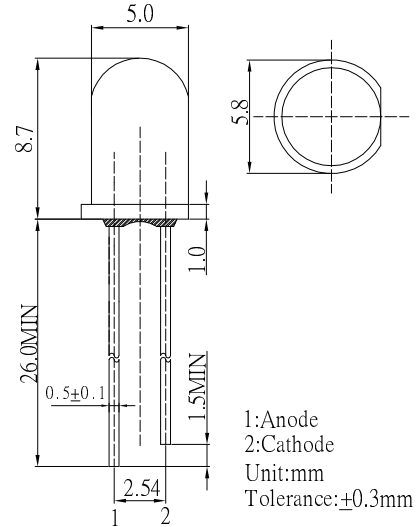

■ **Absolute Maximum Rating**

(Ta=25°C)

Item	Symbol	Value	Unit
Power Supply	Voltage	5	V
Operating Temperature	Topr	-30 ~ +85	°C
Storage Temperature	Tstg	-40 ~ +100	°C
Lead Soldering Temperature	Tsol	260°C / 5sec	-

■ **Directivity**

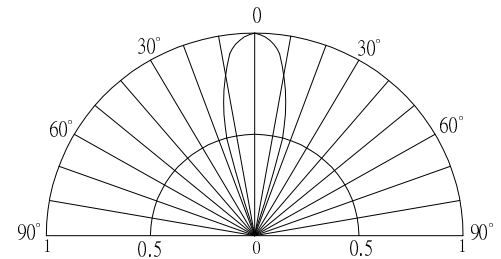

■ **Electrical -Optical Characteristics**

(Ta=25°C)

Item	Symbol	Condition	Min.	Typ.	Max.	Unit
DC Forward Voltage	V <sub>fd</sub>	I <sub>F</sub> =20mA	3.0	3.3	5.0	V
DC Reverse Current	I <sub>R</sub>	V <sub>R</sub> =5V	-	-	10	μA
Chromaticity Coordinates*	x	I <sub>F</sub> =20mA	-	0.45	-	
	y	I <sub>F</sub> =20mA	-	0.17	-	
Luminous Intensity*	I <sub>v</sub>	I <sub>F</sub> =20mA	2000	2500	-	mcd
50% Power Angle	2θ <sub>1/2</sub>	I <sub>F</sub> =20mA	-	30	-	deg

\*1 Tolerance of dominant wavelength is ±1nm

\*2 Tolerance of luminous intensity is ±15%

\*3 Tolerance of Frequency is ±20%