

Data sheet | Item number: 221-415

COMPACT Splicing Connectors; 5-conductor connector; with operating levers; Max.ambient operating temp. 85 °C

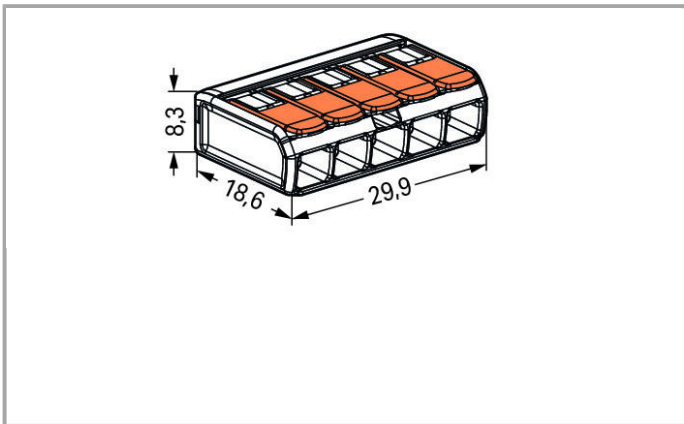

[www.wago.com/221-415](http://www.wago.com/221-415)



## Data

### Electrical data

#### Ratings per IEC/EN 60664-1

Rated voltage (II / 2)	450 V
Rated impulse voltage (II / 2)	4 kV
Rated current	32 A
Legend (ratings)	(II / 2) ≙ Overvoltage category II / Pollution degree 2

## Connection data

Connection technology	CAGE CLAMP®
Actuation type	Lever
Connectable conductor materials	Copper
Nominal cross section	4 mm <sup>2</sup>
Solid conductor	0.2 ... 4 mm <sup>2</sup> / 24 ... 12 AWG
Stranded conductor	0.2 ... 4 mm <sup>2</sup> / 24 ... 12 AWG
Fine-stranded conductor	0.14 ... 4 mm <sup>2</sup> / 24 ... 12 AWG
Strip length	11 mm / 0.43 Inch
Total number of connection points	5
Total number of potentials	1
Type of wiring	Side-entry wiring

## Geometrical Data

Width	29.9 mm / 1.177 inch
Height	8.3 mm / 0.327 inch
Depth	18.6 mm / 0.732 inch

## Material Data

Color	transparent
Flammability class per UL94	V2
Weight	4.048 g

## Environmental Requirements

Surrounding air (operating) temperature	85 °C
T-Marking per EN 60998	T85

## Commercial data

Country of origin	DE
GTIN	4055143234658
Customs Tariff No.	85369010000
Product Group	7 (Push Wire Conn.)

## Approvals / Certificates

### Country specific Approvals



Logo	Approval	Certificate name
	CCA DEKRA Certification B.V.	NTR NL-7642





CCA  
DEKRA Certification B.V.

71-101731

## Ship Approvals





Logo	Approval	Certificate name
	ABS American Bureau of Shipping	15-HG1419918-PDA
	DNV GL Det Norske Veritas, Germanischer Lloyd	TAE000015T
	LR Lloyds Register	04/20013 (E6)





## UL-Approvals

Logo	Approval	Certificate name
	UL UL International Germany GmbH	E69654
	UL Underwriters Laboratories Inc.	E201573

## Compatible products

## Mounting adapter

	Item no.: 221-500 Mounting carrier; 221 Series - 4 mm <sup>2</sup> ; for DIN-35 rail mounting/screw mounting	<a href="http://www.wago.com/221-500">www.wago.com/221-500</a>
	Item no.: 221-505 Mounting carrier; for 5-conductor terminal blocks; 221 Series - 4 mm <sup>2</sup> ; for screw mounting	<a href="http://www.wago.com/221-505">www.wago.com/221-505</a>
	Item no.: 221-505/000-004 Mounting carrier; for 5-conductor terminal blocks; 221 Series - 4 mm <sup>2</sup> ; for screw mounting	<a href="http://www.wago.com/221-505/000-004">www.wago.com/221-505/000-004</a>
	Item no.: 221-515 Mounting carrier; for 5-conductor terminal blocks; 221 Series - 4 mm <sup>2</sup> ; with snap-in mounting foot for horizontal mounting	<a href="http://www.wago.com/221-515">www.wago.com/221-515</a>
	Item no.: 221-515/000-004 Mounting carrier; for 5-conductor terminal blocks; 221 Series - 4 mm <sup>2</sup> ; with snap-in mounting foot for horizontal mounting	<a href="http://www.wago.com/221-515/000-004">www.wago.com/221-515/000-004</a>

	<b>Item no.: 221-525</b> Mounting carrier; for 5-conductor terminal blocks; 221 Series - 4 mm <sup>2</sup> ; with snap-in mounting foot for vertical mounting	<a href="http://www.wago.com/221-525">www.wago.com/221-525</a>
	<b>Item no.: 221-525/000-004</b> Mounting carrier; for 5-conductor terminal blocks; 221 Series - 4 mm <sup>2</sup> ; with snap-in mounting foot for vertical mounting	<a href="http://www.wago.com/221-525/000-004">www.wago.com/221-525/000-004</a>
	<b>Item no.: 222-505</b> Strain relief plate; for mounting carrier; 221 or 222 Series, can be snapped	<a href="http://www.wago.com/222-505">www.wago.com/222-505</a>
	<b>Item no.: 222-510</b> Angled DIN-rail adapter; in combination with mounting carrier; 221-500 or 222-500; for DIN-35 rail mounting	<a href="http://www.wago.com/222-510">www.wago.com/222-510</a>

**Downloads**

**Documentation**

**Bid Text**

221-415	Mar 9, 2018	DOC 25.6 kB	Download
---------	-------------	----------------	----------

**smartDATA**

**CAD data**

3D Download 221-415	URL	Download
---------------------	-----	----------

Subject to changes.