

KW7-03-G06

Features

1. Various levers and terminals are available.
2. Snap action, compact design, suit for small space.
3. Long operating life, high reliability, which could, save the cost.
4. Various rating and temperature resistance degree are available.
5. CQC, CE, UL, VDE approvals.

Application Area

Widely applied in machinery, production line, elevator equipment etc.

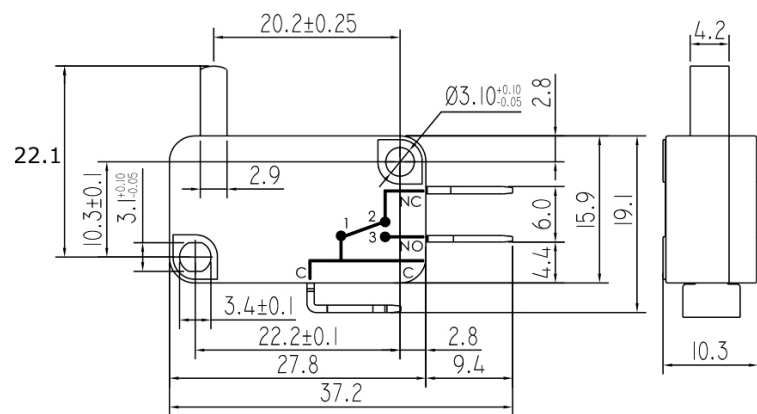

Rating		16A, 125/250VAC
Initial contact resistance		25mΩ max.
Initial insulation resistance		100MΩ min. (at 500VDC)
Dielectric strength	Between non-consecutive terminals	1000Vrms, 50/60Hz for 1 min
	Between non-current carrying metal parts and each terminal	1500Vrms, 50/60Hz for 1 min
	Between ground and each terminal	1500Vrms, 50/60Hz for 1 min
Shock resistance	Destruction	O.F.>0.5N: 1000m/s ² max. (Approx. 100G) max. O.F.≤0.5N: 400m/s ² max. (Approx. 40G) max.
	Malfunction	O.F.>0.5N: 200m/s ² max. (Approx. 20G) max. O.F.≤0.5N: 100m/s ² max. (Approx. 10G) max.
Vibration resistance		10-55Hz, 1.5mm double amplitude
Operating life	Mechanical life	1,000,000 operations min
	Electrical life	50,000 operations min.
Ambient temperature		-10°C to +85°C
Ambient humidity		85%RH max.
Operating frequency	Mechanical	60 times/min
	Electrical	25 times/min
Operating speed		0.01mm-1cm/s
Protection degree		IP40