

KW12-8-C03

Features

- 1.Compact design, small size, suit for small space.
- 2.Snap action, high sensitivity and small contact gap
- 3.Long operating life, high reliability.
- 4.Various levers and terminals are available.
- 5.CE,CQC,UL approvals, quality is reliable.

Application Area

Widely applied in machinery,productione line,elevator equipment etc.

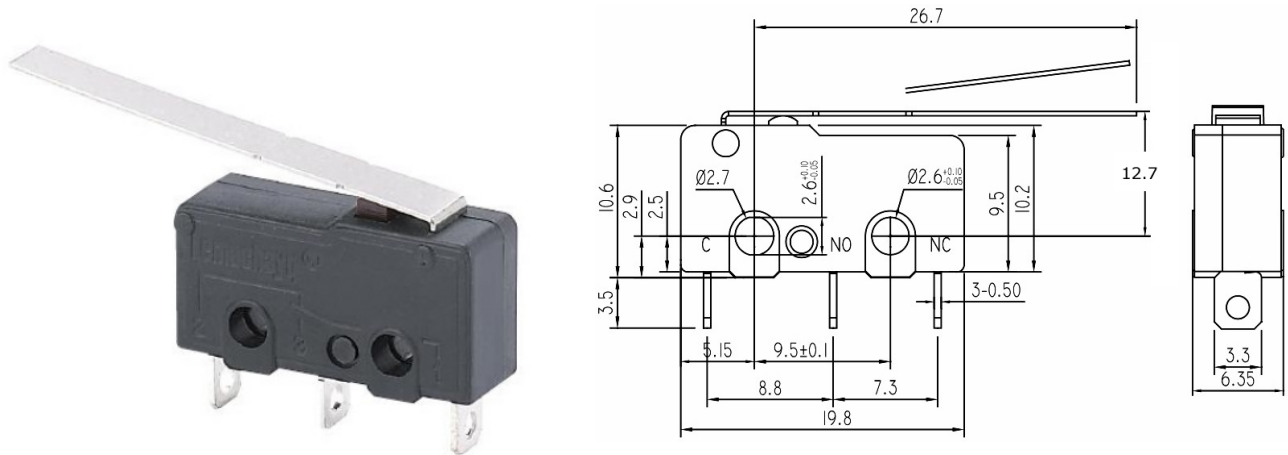

Rating		5A 125/250VAC
Initial contact resistance		25mΩ max.
Initial insulation resistance		100MΩ min. (at 500VDC)
Dielectric strength	Bestween non-consecutive terminals	1000Vrms, 50/60Hz for 1 min
	Between non-current carrying metal parts and each terminal	1,500Vrms, 50/60Hz for 1 min
	Between ground and each terminal	1,500Vrms, 50/60Hz for 1 min
Shock resistance	Destruction	O.F.>0.5N: 1000m/s ² (Approx. 100G) max. O.F.≤0.5N: 400m/s ² (Approx. 40G) max.
	Malfunction	O.F.>0.5N: 200m/s ² (Approx. 20G) max. O.F.≤0.5N: 100m/s ² (Approx. 10G) max.
Vibration resistance		10-55Hz,1.5mm double amplitude
Operating life	Mechanical life	500,000 operations min.
	Electrical life	50,000 operations min.
Ambient temperature		-25°C to +85°C
Ambient humidity		85%RH max.
Operating frequency	Mechanical	60 times/min
	Electrical	25 times/min
Operating speed		0.1mm-1m/s
Protection degree		IP40